

INDICE

CONTENTS

• PRELISTINO _INTRODUCTION.....	pag. page	2
• PIEDINI, ZOCCOLI _FEET, PLINTHS.....		6
• ELEMENTI BASE _BASE MODULES.....		8
• ELEMENTI PENSILE _HANGING MODULES.....		18
• TOP, MENSOLE E SCHIENE _TOPS, SHELVES AND BACKS.....		26
• LIBRERIA _BOOKCASE.....		33
• COLONNE _BOOKCASE'S STRUCTURE.....		41
• MADIE _SIDEBOARDS.....		50
• TAVOLI, SEDIE, ACCESSORI _TABLES, CHAIRS, ACCESSORIES.....		51
• MAGGIORAZIONI PER LAVORAZIONI SPECIALI-SU MISURA _SURCHARGE FOR SPECIAL WORKINGS-CUSTOM MADE.....		53
• COMPOSIZIONI A CATALOGO _COMPOSITION AS PER CATALOGUE.....		54

PIEDINI, ZOCCOLI
FEET, PLINTHS

ELEMENTI BASE
BASE MODULES

ELEMENTI PENSILE
HANGING MODULES

TOP, MENSOLE E SCHIENE
TOPS, SHELVES AND BACKS

LIBRERIA
BOOKCASE

COLONNE
BOOKCASE'S STRUCTURE

MADIE, TAVOLI, SEDIE, ACCESSORI
SIDEBOARDS, TABLES, CHAIRS, ACCESSORIES

COMPOSIZIONI A CATALOGO
COMPOSITION AS PER CATALOGUE

CARATTERISTICHE TECNICHE

TECHNICAL FEATURES

ELEMENTI COMPONENTI: (Basi e pensili)

- STRUTTURA**..... • Scocca realizzata in pannelli in agglomerato di legno, a spessore 19, impiallacciati frassino o laccati, schienali a spessore 4 nobilitati.
- FRONTALI** • Ante legno realizzate con pannelli in MDF a spessore 23 laccati o in legno massello frassino.
• Ante vetro a telaio realizzate con pannelli in massello di frassino spessore 23 o MDF laccato spessore 23 con vetro a spessore 4.
• Cassetti realizzati con pannelli in MDF a spessore 23 laccati o in legno massello frassino, con struttura interna composta da sponde in agglomerato di legno a spessore 12 e fondo in agglomerato di legno a spessore 8 nobilitato tinta alluminio.
• Guide tipo quadro invisibili con carrello di scorrimento dotato di fermo antisgancio e regolazione verticale.
- TOP** • Pannelli in agglomerato di legno, a spessore 12, 26 o 51 impiallacciati frassino o laccati.
- ZOCCOLI**..... • Zoccoli diritti: pannelli in agglomerato di legno, a spessore 35, impiallacciati frassino o laccati.
• Zoccolo sagomato perimetrale: di legno massello frassino altezza 60.
- MENSOLE**..... • Legno: pannelli in agglomerato di legno, a spessore 30 o 51, impiallacciati frassino o laccati, predisposti per fissaggio a muro su pannelli boiserie tramite supporti a scomparsa.
- SCHIENE ATTREZZATE**.... • Pannelli in agglomerato di legno, a spessore 26, impiallacciati frassino o laccati predisposti per il fissaggio a muro o con attacchi metallici a scomparsa regolabili in altezza.

LIBRERIA:

- STRUTTURA**..... • Spalle realizzate con pannelli in agglomerato di legno, a spessore 30 e 51, impiallacciati frassino o laccati.
• Provviste di piedini livellatori per la regolazione in altezza. La foratura è realizzata solo in corrispondenza dei ripiani.
• Ripiani e tramezza realizzati con pannelli in agglomerato di legno, a spessore 30 e 51, impiallacciati frassino o laccati.
• Fondi realizzati con pannelli in agglomerato di legno, a spessore 57, impiallacciati frassino o laccati.
• Schienali realizzati in pannelli di particelle di legno a spessore 12, impiallacciati o laccati.
- FRONTALI**..... • Ante legno realizzate con pannelli in MDF a spessore 23 laccati o in legno massello frassino.
• Ante vetro a telaio realizzate con pannelli in massello di frassino spessore 23 o MDF laccato spessore 23 con vetro a spessore 4.
• Cassetti realizzati con pannelli in MDF a spessore 23, laccati o in legno massello frassino, con struttura interna composta da sponde in agglomerato di legno a spessore 12 e fondo in agglomerato di legno a spessore 8 nobilitato tinta alluminio.
• Sistema di guida invisibile con carrello di scorrimento dotato di fermo antisgancio e regolazione verticale.

MADIE:

- STRUTTURA**..... • Scocca realizzata in pannelli in agglomerato di legno, a spessore 19, impiallacciati frassino o laccati, schienali a spessore 18 laccati.
- FRONTALI** • Ante legno realizzate con pannelli in MDF a spessore 23 laccati o in legno massello frassino.
• Apertura dei frontali complanare: viene montato il meccanismo Slider di Bortoluzzi Sistemi S.r.l. il quale garantisce un'ottima scorrevolezza e massima silenziosità.
• Apertura e chiusura delle ante sono rallentate mediante un ammortizzatore rotativo.
- PIEDINI**..... • Realizzati con pannelli in agglomerato di legno, a spessore 51, impiallacciati frassino o laccati.

- MATERIALI**..... • Tutti i pannelli di particelle di legno utilizzati sono di classe E1, a basso contenuto di formaldeide.
Le vernici rispondono ai requisiti di sicurezza per il contenuto di metalli pesanti conformemente alle direttive europee applicabili.

- TOLLERANZE**..... • Gli elementi con finiture in essenza possono subire variazioni di colore dovute alla luce.
In caso di completamento sono possibili piccole variazioni di tonalità che nel tempo tenderanno ad attenuarsi.

- NOTE TECNICHE**..... • Per i tagli a misura il relativo importo viene riportato nel listino, e comunque non potrà essere inferiore al 40% del prezzo dell'elemento di serie.

CARATTERISTICHE TECNICHE

TECHNICAL FEATURES

COMPOUND ELEMENTS: (Base and hanging modules)

- STRUCTURE**..... • Structure made with agglomerate panels, Th.19, ash-wood veneered or laquered, backs Th.4 melamine faced.
- FRONTALS**..... • Wooden doors made with MDF panels Th.23 laquered or with solid ash-wood.
• Glass doors made with Th.4 glass and solid ash-wood frame Th.23, or MDF laquered frame Th.23.
• Drawers made with MDF panels Th.23 laquered or with solid ash-wood. Internal structure made with agglomerate sides Th.12 and bottom made with agglomerate panels Th.8 melamine aluminium faced.
• Invisible metal runners with hooking stopper and vertical regulation.
- TOP**..... • Agglomerate panels Th.12,26 or 51, ash-wood veneered or laquered.
- PLINTHS**..... • Straight plinths: agglomerate panels, Th.35, ash-wood veneered or laquered.
• Shaped perimetric plinths: solid ash-wood H.60.
- SHELVES**..... • Wood: agglomerate panels Th.30 or 51, ash-wood veneered or laquered, prepared for fixing to wall or boiserie with invisible brackets.
- HANGING PANELS**..... • Agglomerate panels Th. 26, ash-wood veneered or laquered, equipped with wall hooks with hiding levelers.

BOOKCASE:

- STRUCTURE**..... • Sides made with agglomerate panels, Th.30 and 51, ash-wood veneered or laquered
Complete with regulating feet. The fixtures are ready-fitted according to the arrangement ordered.
• Structural shelves and partitions made with agglomerate panels, Th.30 or 51, ash-wood veneered or laquered.
• Bottom shelves made with agglomerate panels, Th.57, ash-wood veneered or laquered.
• Backs made with agglomerate panels, Th.12, ash-wood veneered or laquered.
- FRONTALS**..... • Wooden doors made with MDF panels Th.23 laquered or solid ash-wood.
• Glass doors made with Th.4 glass and solid ash-wood frame Th.23 or MDF laquered frame Th.23.
• Drawers made with MDF panels Th.23 laquered or with solid ash-wood. Internal structure made with agglomerate sides Th.12 and bottom made with agglomerate panels Th.8 melamine aluminium faced.
• Invisible metal runners with hooking stopper and vertical regulation.

SIDEBOARDS:

- STRUCTURE**..... • Structure made with agglomerate panels, Th.19, ash-wood veneered or laquered, backs Th.18 laquered.
- FRONTALS**..... • Wooden doors made with MDF panels, Th.23, laquered or solid ash-wood.
• Sliding coplanar doors: it is mounted the mechanism "Slider" of Bortoluzzi Sistemi S.r.l. which guarantees an optimal sliding and noiseless.
Opening and closing doors slowed by a rotary damper.
- FEETS**..... • Made with agglomerate panels, Th.51, ash-wood veneered or laquered.

- MATERIALS**..... • Agglomerate panels are E1 class, with a low formaldehyde content.
Varnishes respect European directives concerning safety from heavymetals effects.

- TOLERANCES**..... • Modules with wood finishes may incur changes in colour due to light. In the event of additions, there may be slight differences in shade which tend to attenuate with time.

- TECHNICAL NOTES**..... • Surcharges for custom-made elements are specified in the price list, in any case not lower than 40% of the standard element's price.

MODULARITÀ

MODULARITY

ELEMENTI BASE

BASE MODULES

P. d. 450

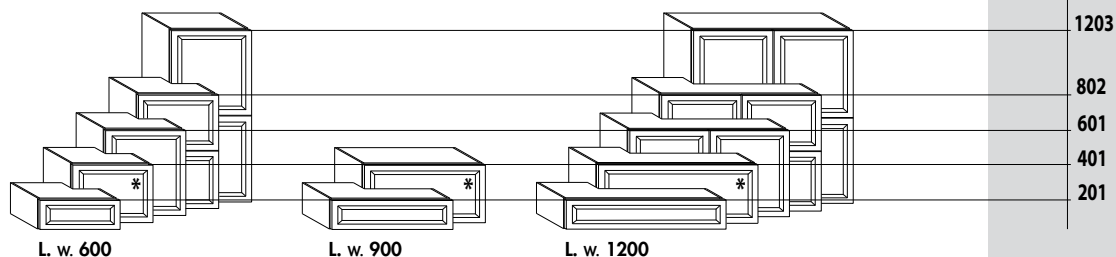

P. d. 600

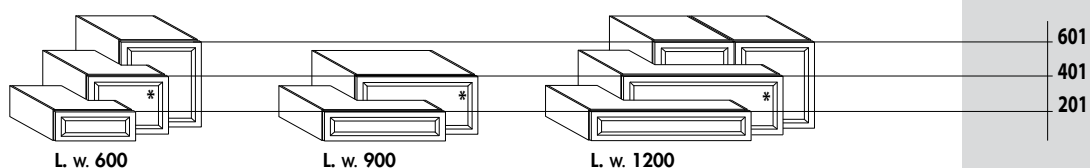

* Elemento disponibile con anta battente, cassetti o cassettone
Available with wing doors, drawers and high drawers

ELEMENTI PENSILE

HANGING MODULES

Tutti gli elementi pensile sono disponibili con ante legno o ante vetro
All the hanging modules are available with wooden or glass doors

P. d. 350

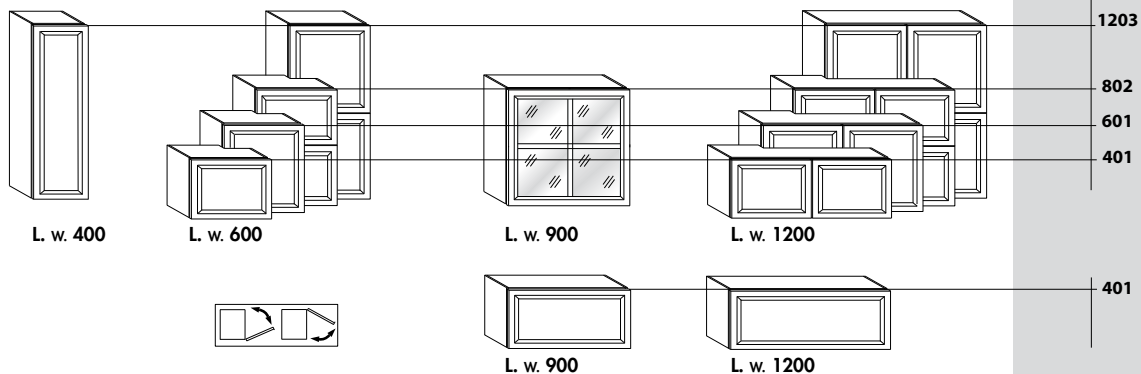

ELEMENTI LIBRERIA

BOOKCASE'S ELEMENTS

Spalle e ripiani disponibili a spessore 51 (nella profondità 377)
Sides and shelves available in thickness 51 (in depth 377)

P. d. 377

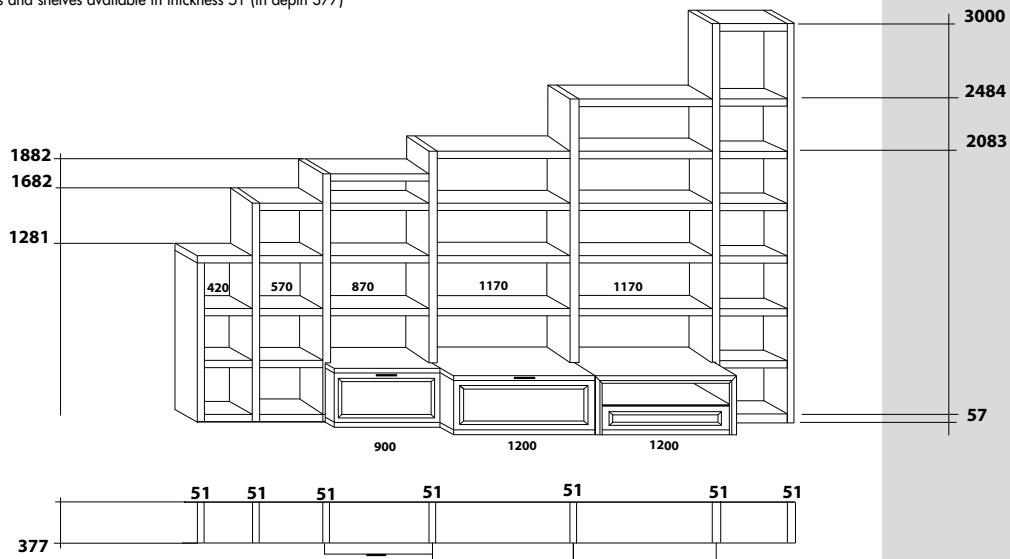

MANIGLIE HANDLES

Maniglia Handle "FLAG"

Disponibile su cassetto, cassettone, anta legno, anta vetro
Available on drawer-high drawer-wooden door-glass door



L.w. 105 **Alluminio satinato** Satined aluminium..... **4PO3008**
Interasse Interaxis 96 **Laccato opaco** Matt lacquered..... **4PO3014**

€ 5,00 (Già conteggiato nel prezzo degli elementi)
(Price already included in the amount)

Maniglia Handle "ICARO"

Disponibile su cassetto, cassettone, anta legno, anta vetro
Available on drawer-high drawer-wooden door-glass door



L.w. 160 **Frassino tinto o laccato**
Interasse Interaxis 96 Stained or lacquered ash-wood..... **4PO3035**

€ 5,00 (Già conteggiato nel prezzo degli elementi)
(Price already included in the amount)

Maniglia Handle "TECNA"

Disponibile su cassetto, cassettone
Available on drawer-high drawer



Interasse Interaxis 96
L.w. 600 **Alluminio lucido** Polished aluminium..... **4PO3120**
Laccato opaco Matt lacquered..... **4PO3130**

L.w. 900 **Alluminio lucido** Polished aluminium..... **4PO3120**
Laccato opaco Matt lacquered..... **4PO3130**

L.w. 1200 **Alluminio lucido** Polished aluminium..... **4PO3120**
Laccato opaco Matt lacquered..... **4PO3130**

€ 15,00 (Prevista maggiorazione di € 10,00 cad.)
(Surcharge € 10,00 each)

Maniglia Handle "FLAG"

Disponibile su cassetto, cassettone, anta legno
Available on drawer-high drawer-wooden door

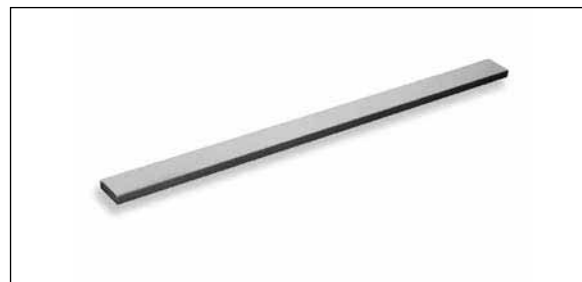

L.w. 308 **Alluminio lucido** Polished aluminium..... **4PO3017**
Interasse Interaxis 96

€ 10,00 (Già conteggiato nel prezzo degli elementi)
(Price already included in the amount)

Pomolo Knob "TONDO"

Disponibile su cassetto, cassettone, anta legno
Available on drawer-high drawer-wooden door

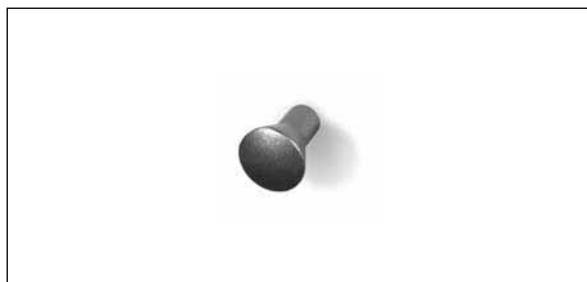

Alluminio satinato Satined aluminium..... **4PO3013**

€ 5,00 (Già conteggiato nel prezzo degli elementi)
(Price already included in the amount)

Apertura a spinta Finger tip opening

Disponibile su cassetto, cassettone, anta legno, anta vetro
Available on drawer-high drawer-wooden door-glass door



Su anta On door..... **4PO3012**
Su cassetto On drawer..... **4PO3115**

€ 5,00 (Già conteggiato nel prezzo degli elementi)
(Price already included in the amount)

ZOCCOLI ZENITH

ZENITH PLINTHS

- Altezza zoccolo 60, spessore 30
- Height 60, thickness 30

Codice
Code

Laccato, Laccato consumato, Frassino tinto,
Frassino laccato opaco, Frassino decapè
lacquered, "Consumato" laquered, Stained ash-wood,
Ash-wood matt lacquered, Ash-wood "decapè"

ZOCCOLO FRONTALE P. 30

PLINTH D. 30

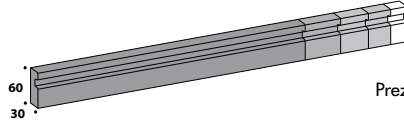
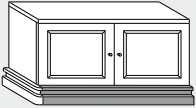

Prezzo al metro lineare
Price per meter length

Z.975

70,00

ZOCCOLO LATERALE PER BASE SPORGENTE P. 600

LATERAL PLINTH D. 600

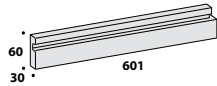
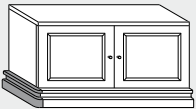

Destro
Right

Z.976

65,00

Sinistro
Left

Z.977

65,00

ZOCCOLO LATERALE PER BASE SPORGENTE P. 450

LATERAL PLINTH D. 450

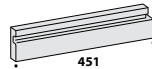
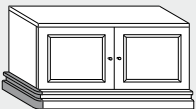

Destro
Right

Z.978

60,00

Sinistro
Left

Z.979

60,00

ZOCCOLO LATERALE DI COMPENSAZIONE PER BASI P. 600

LATERAL PLINTH D. 600

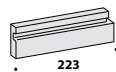
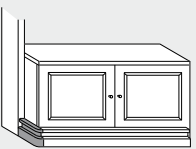

Destro
Right

Z.980

55,00

Sinistro
Left

Z.981

55,00

ZOCCOLO LATERALE DI COMPENSAZIONE PER BASI P. 450

LATERAL PLINTH D. 450

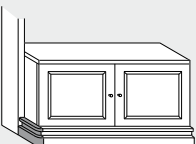

Destro
Right

Z.982

50,00

Sinistro
Left

Z.983

50,00

PIEDINI PER ZOCCOLI "ZENITH"

FOR "ZENITH" PLINTH FEET

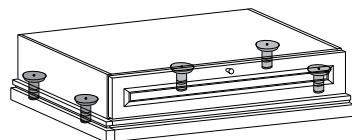





Necessari in presenza di zoccolo "Zenith"
Necessary in the presence of "Zenith" plint

Z.999

5,00

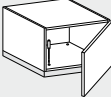
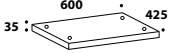
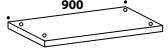
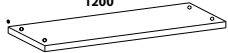
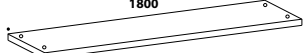
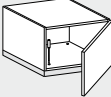
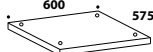
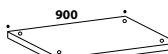
ZOCCOLI E PIEDINI

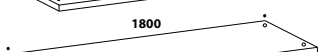
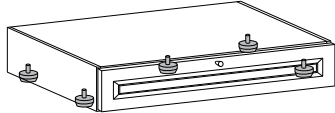
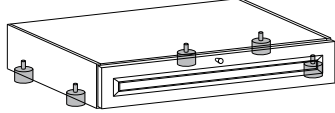
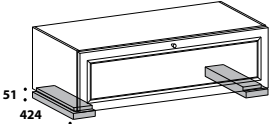
FEET AND PLINTHS

		Codice Code	Laccato, Laccato consumato, Frassino tinto, Frassino laccato opaco, Frassino decapè lacquered, "Consumato" laquered, Stained ash-wood, Ash-wood matt lacquered, Ash-wood "decapè"
ZOCCOLO DIRITTO P. 425 PLINTH D. 425 Elemento completo di piedini regolatori Provided with levelling feet 		L. w. 600	Z.845 78,00
		L. w. 900	Z.849 91,00
		L. w. 1200	Z.846 78,00
		L. w. 1800	Z.847 119,00
ZOCCOLO DIRITTO P. 575 PLINTH D. 575 Elemento completo di piedini regolatori Provided with levelling feet 		L. w. 600	Z.840 81,00
		L. w. 900	Z.844 95,00
		L. w. 1200	Z.841 102,00
		L. w. 1800	Z.842 122,00
PIEDINO ROTONDO BASSO LOW ROUND FOOT Confezione di 5 piedini Package with 5 feet		H. 18	X.812 33,00
PIEDINO ROTONDO ROUND FOOT Confezione di 5 piedini Package with 5 feet		H. 35	C.600 12,00
PIEDINO "FUTON" P. 424 "FUTON" FOOT D. 424 Confezione di 2 piedini Package with 2 feet		H. 51	X.778 171,00
RUOTE PER BASI BASE MODULE CASTORS Portata per singola ruota kg. 15 Capacity of each individual castor 15 kg.	 		X.951 126,00

ELEMENTI BASI BASSE

LOW BASE MODULES

H. 201
P. D. **450**

- **Prezzi non comprensivi di top, zoccolo o piedini.**
- **Prices do not include top, plinth or feet.**

Codice
Code

Laccato, Laccato consumato, Frassino tinto,
Frassino laccato opaco, Frassino decapè
lacquered, "Consumato" laquered, Stained ash-wood,
Ash-wood matt lacquered, Ash-wood "decapè"

1 FRONTALE L. 600
1 FRONTAL W. 600

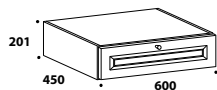

Cassetto
Drawer

Z.286

262,00

Ribalta
Flap

Z.286R

1 FRONTALE L. 900
1 FRONTAL W. 900

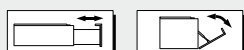
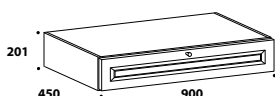

Cassetto
Drawer

Z.289

279,00

Ribalta
Flap

Z.289R

1 FRONTALE L. 1200
1 FRONTAL W. 1200

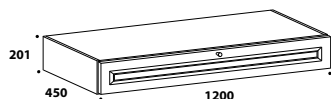

Cassetto
Drawer

Z.300

328,00

Ribalta
Flap

Z.300R

2 FRONTALI L. 1200
2 FRONTALS W. 1200

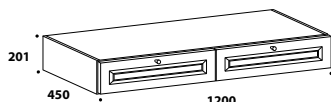

2 Cassetti
2 Drawers

Z.302

355,00

1 Cassetto + 1 Ribalta
1 Drawer + 1 Flap

Z.302R

3 CASSETTI L. 1800
3 DRAWERS W. 1800

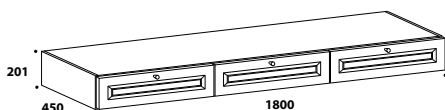

Z.303

482,00

2 FRONTALI L. 1800
2 FRONTALS W. 1800

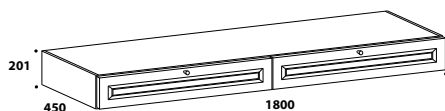

2 Cassetti
2 Drawers

Z.295

457,00

1 Cassetto + 1 Ribalta
1 Drawer + 1 Flap

Z.295R

ELEMENTI BASI BASSE

LOW BASE MODULES

H. 201
P. D. **600**

- Prezzi non comprensivi di top, zoccolo o piedini.
- Prices do not include top, plinth or feet.

Codice
Code

Laccato, Laccato consumato, Frassino tinto,
Frassino laccato opaco, Frassino decapè
lacquered, "Consumato" laquered, Stained ash-wood,
Ash-wood matt lacquered, Ash-wood "decapè"

1 FRONTALE L. 600
1 FRONTAL W. 600

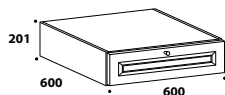

Cassetto
Drawer **Z.286-60**

274,00

Ribalta
Flap **Z.286-60R**

1 FRONTALE L. 900
1 FRONTAL W. 900

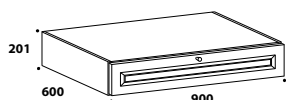

Cassetto
Drawer **Z.289-60**

290,00

Ribalta
Flap **Z.289-60R**

1 FRONTALE L. 1200
1 FRONTAL W. 1200

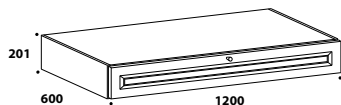

Cassetto
Drawer **Z.300-60**

340,00

Ribalta
Flap **Z.300-60R**

2 FRONTALI L. 1200
2 FRONTALS W. 1200

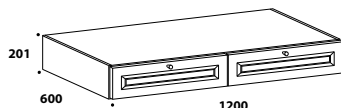

2 Cassetti
2 Drawers **Z.302-60**

372,00

1 Cassetto + 1 Ribalta
1 Drawer + 1 Flap **Z.302-60R**

3 CASSETTI L. 1800
3 DRAWERS W. 1800

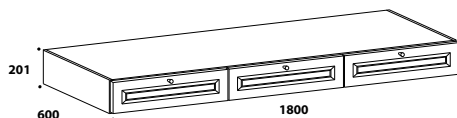

Z.303-60

499,00

2 FRONTALI L. 1800
2 FRONTALS W. 1800

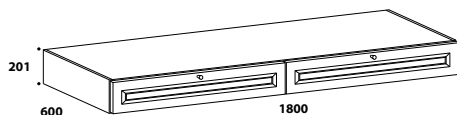

2 Cassetti
2 Drawers **Z.295-60**

474,00

1 Cassetto + 1 Ribalta
1 Drawer + 1 Flap **Z.295-60R**



ELEMENTI BASI

BASE MODULES

H. 401
P. D. **450**

- **Prezzi non comprensivi di top, zoccolo o piedini.**
- **Prices do not include top, plinth or feet.**

Codice
Code

Laccato, Laccato consumato, Frassino tinto,
Frassino laccato opaco, Frassino decapè
lacquered, "Consumato" laquered, Stained ash-wood,
Ash-wood matt lacquered, Ash-wood "decapè"

1 ANTA LEGNO L. 600
1 WOODEN DOOR W. 600

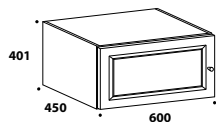

Z.002

272,00

2 FRONTALI L. 600
2 FRONTALS W. 600

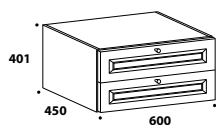

2 Cassetti
2 Drawers

Z.004

378,00



1 Cassetto + 1 Ribalta
1 Drawer + 1 Flap

Z.004R

1 CASSETTO + VANO GIORNO L. 600
1 DRAWER + OPEN SPACE W. 600

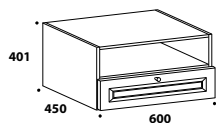

Z.160

312,00

1 CASSETTONE L. 600
1 HIGH DRAWER W. 600

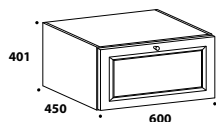

Z.007

313,00

2 FRONTALI L. 900
2 FRONTALS W. 900

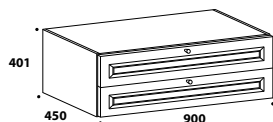

2 Cassetti
2 Drawers

Z.206

474,00



1 Cassetto + 1 Ribalta
1 Drawer + 1 Flap

Z.206R

1 CASSETTO + VANO GIORNO L. 900
1 DRAWER + OPEN SPACE W. 900

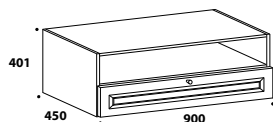

Z.161

363,00

ELEMENTI BASI

BASE MODULES

H. 401
P. D. **450**

- **Prezzi non comprensivi di top, zoccolo o piedini.**
- **Prices do not include top, plinth or feet.**

Codice
Code

Laccato, Laccato consumato, Frassino tinto,
Frassino laccato opaco, Frassino decapè
lacquered, "Consumato" laquered, Stained ash-wood,
Ash-wood matt lacquered, Ash-wood "decapè"

1 CASSETTONE L. 900
1 HIGH DRAWER W. 900

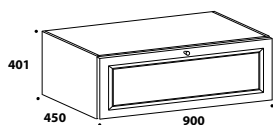

Z.199

370,00

2 ANTE LEGNO L. 1200
2 WOODEN DOORS W. 1200

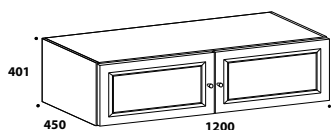

Z.202

389,00

2 FRONTALI L. 1200
2 FRONTALS W. 1200

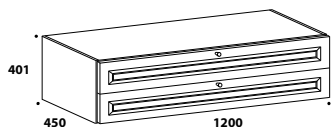

2 Cassetti
2 Drawers

Z.204

481,00



1 Cassetto + 1 Ribalta
1 Drawer + 1 Flap

Z.204R

1 CASSETTO + VANO GIORNO L. 1200
1 DRAWER + OPEN SPACE W. 1200

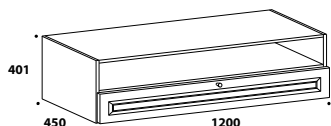

Z.162

377,00

1 CASSETTONE L. 1200
1 HIGH DRAWER W. 1200

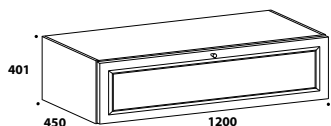

Z.207

384,00

ELEMENTI BASI

BASE MODULES

H. 401
P. D. **600**

- Prezzi non comprensivi di top, zoccolo o piedini.
- Prices do not include top, plinth or feet.

Codice
Code

Laccato, Laccato consumato, Frassino tinto,
Frassino laccato opaco, Frassino decapè
lacquered, "Consumato" laquered, Stained ash-wood,
Ash-wood matt lacquered, Ash-wood "decapè"

1 ANTA LEGNO L. 600
1 WOODEN DOOR W. 600

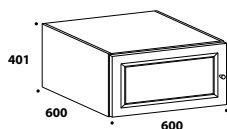

Z.002-60

288,00

2 FRONTALI L. 600
2 FRONTALS W. 600

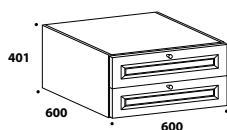

2 Cassetti
2 Drawers

Z.004-60

391,00



1 Cassetto + 1 Ribalta
1 Drawer + 1 Flap

Z.004-60R

1 CASSETTO + VANO GIORNO L. 600
1 DRAWER + OPEN SPACE W. 600

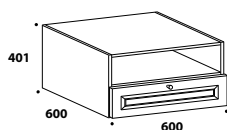

Z.160-60

325,00

1 CASSETTONE L. 600
1 HIGH DRAWER W. 600

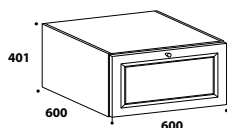

Z.007-60

326,00

2 FRONTALI L. 900
2 FRONTALS W. 900

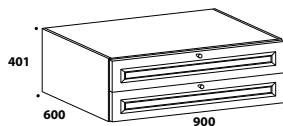

2 Cassetti
2 Drawers

Z.206-60

485,00



1 Cassetto + 1 Ribalta
1 Drawer + 1 Flap

Z.206-60R

1 CASSETTO + VANO GIORNO L. 900
1 DRAWER + OPEN SPACE W. 900



Z.161-60

374,00

ELEMENTI BASI

BASE MODULES

H. 401
P. D. **600**

- **Prezzi non comprensivi di top, zoccolo o piedini.**
- **Prices do not include top, plinth or feet.**

Codice
Code

Laccato, Laccato consumato, Frassino tinto,
Frassino laccato opaco, Frassino decapè
lacquered, "Consumato" laquered, Stained ash-wood,
Ash-wood matt lacquered, Ash-wood "decapè"

1 CASSETTONE L. 900
1 HIGH DRAWER W. 900

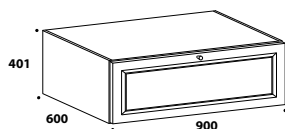

Z.199-60

381,00

2 ANTE LEGNO L. 1200
2 WOODEN DOORS W. 1200

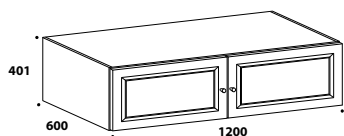

Z.202-60

401,00

2 FRONTALI L. 1200
2 FRONTALS W. 1200

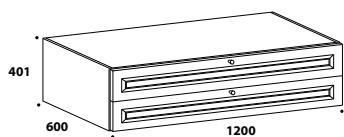

2 Cassetti
2 Drawers

Z.204-60

492,00

1 Cassetto + 1 Ribalta
1 Drawer + 1 Flap

Z.204-60R

1 CASSETTO + VANO GIORNO L. 1200
1 DRAWER + OPEN SPACE W. 1200

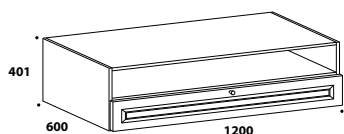

Z.162-60

389,00

1 CASSETTONE L. 1200
1 HIGH DRAWER W. 1200

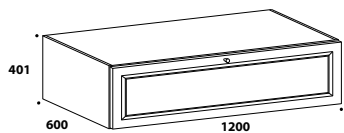

Z.207-60

396,00

- **Prezzi non comprensivi di top, zoccolo o piedini.**
- **Prices do not include top, plinth or feet.**

Codice
Code

Laccato, Laccato consumato, Frassino tinto,
Frassino laccato opaco, Frassino decapè
lacquered, "Consumato" laquered, Stained ash-wood,
Ash-wood matt lacquered, Ash-wood "decapè"

1 ANTA LEGNO L. 600
1 WOODEN DOOR W. 600

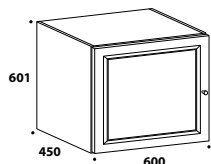

Maggiorazione per decoro flower: € 60,00 (caduna)
Surcharge for flower decoration: € 60,00 (each)

Z.008

334,00

3 CASSETTI L. 600
3 DRAWERS W. 600

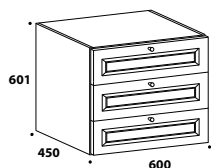

Z.045

491,00

1 ANTA LEGNO L. 600
1 WOODEN DOOR W. 600

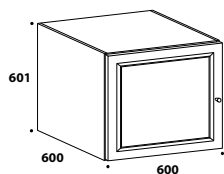

Maggiorazione per decoro flower: € 60,00 (caduna)
Surcharge for flower decoration: € 60,00 (each)

Z.008-60

360,00

3 CASSETTI L. 600
3 DRAWERS W. 600

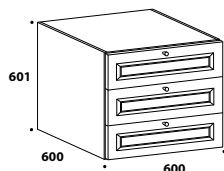

Z.045-60

506,00

ELEMENTI BASI

BASE MODULES

P. D. 450

- Vetri disponibili: trasparente, riflettente
- Glass available: transparent, reflecting
- Prezzi non comprensivi di top, zoccolo o piedini.
- Prices do not include top, plinth or feet.

Codice
Code

Laccato, Laccato consumato, Frassino tinto,
Frassino laccato opaco, Frassino decapè
lacquered, "Consumato" laquered, Stained ash-wood,
Ash-wood matt lacquered, Ash-wood "decapè"

2 ANTE LEGNO L. 600 H. 802
2 WOODEN DOORS W. 600 H. 802

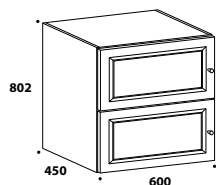

Z.013

399,00

4 ANTE LEGNO L. 1200 H. 802
4 WOODEN DOORS W. 1200 H. 802

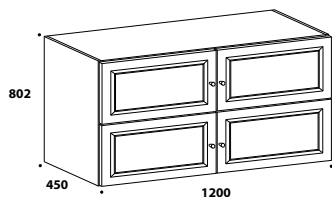

Z.213

584,00

2 ANTE LEGNO L. 600 H. 1203
2 WOODEN DOORS W. 600 H. 1203

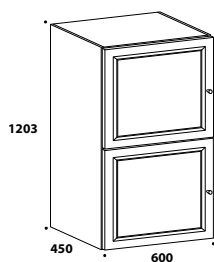

Z.019

550,00

Maggiorazione per decora flower: € 60,00 (caduna)
Surcharge for flower decoration: € 60,00 (each)

**1 ANTA LEGNO + 1 ANTA
VETRO L. 600 H. 1203**
1 WOODEN DOOR + 1 GLASS DOOR
W. 600 H. 1203

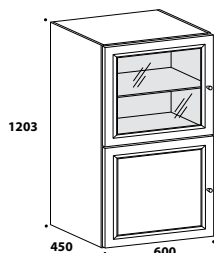

Z.028

610,00

Maggiorazione per frontale vetro con inglesina: € 22,00 (caduna)
Surcharge for glass door with grating: € 22,00 (each)

Maggiorazione per decora flower: € 60,00 (caduna)
Surcharge for flower decoration: € 60,00 (each)

ELEMENTI BASI

BASE MODULES

H. 1203
P. D. 450

- Vetri disponibili: trasparente, riflettente
- Glass available: transparent, reflecting
- Prezzi non comprensivi di top, zoccolo o piedini.
- Prices do not include top, plinth or feet.

Codice
Code

Laccato, Laccato consumato, Frassino tinto,
Frassino laccato opaco, Frassino decapè
lacquered, "Consumato" laquered, Stained ash-wood,
Ash-wood matt lacquered, Ash-wood "decapè"

2 ANTE VETRO L. 600

2 GLASS DOORS W. 600

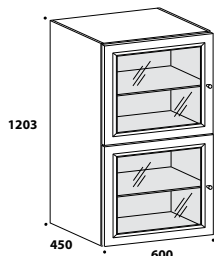

Maggiorazione per frontale vetro con inglesina: € 22,00 (caduna)
Surcharge for glass door with grating: € 22,00 (each)

Z.046

670,00

4 ANTE LEGNO L. 1200

4 WOODEN DOORS W. 1200

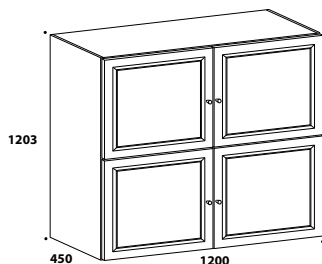

Maggiorazione per decoro flower: € 60,00 (caduna)
Surcharge for flower decoration: € 60,00 (each)

Z.240

828,00

2 ANTE LEGNO + 2 ANTE VETRO L. 1200

2 WOODEN DOORS + 2 GLASS DOORS W. 1200

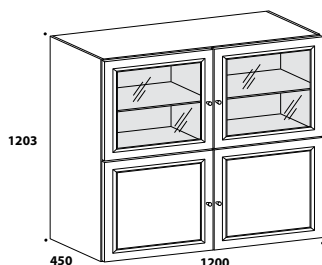

Maggiorazione per frontale vetro con inglesina: € 22,00 (caduna)
Surcharge for glass door with grating: € 22,00 (each)
Maggiorazione per decoro flower: € 60,00 (caduna)
Surcharge for flower decoration: € 60,00 (each)

Z.24002

948,00

4 ANTE VETRO L. 1200

4 GLASS DOORS W. 1200

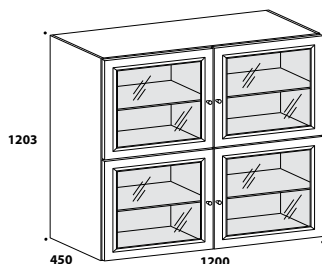

Maggiorazione per frontale vetro con inglesina: € 22,00 (caduna)
Surcharge for glass door with grating: € 22,00 (each)

Z.24001

1.068,00

ELEMENTI BASI

BASE MODULES

Codice
Code

Laccato, Laccato consumato, Frassino tinto,
Frassino laccato opaco, Frassino decapè
lacquered, "Consumato" laquered, Stained ash-wood,
Ash-wood matt lacquered, Ash-wood "decapè"

BASE PORTA TV SPECIALE L. 1200 P. 600

TV HOLDER SPECIAL BASE MODULE
W. 1200 D. 600

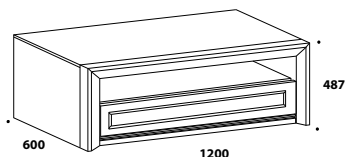

Z.287

720,00

SCHIENA GROSSA CON CORNICE Sp. 80

HANGING PANELS WITH FRAME
Th. 80

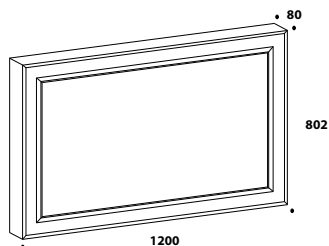

Z.661

490,00

SCHIENALE PORTA TV ORIENTABILE L. 1200 P. 80 H. 802

ADJUSTABLE ELEMENT FOR TELEVISION
W. 1200 D. 80 H. 802

Dotazione:

- Schienale sp. 80
- Meccanismo orientabile
- Foro con tappo passacavi

Equipment:

- Hanging panel th. 80
- Adjustable system
- Round cable hole plug

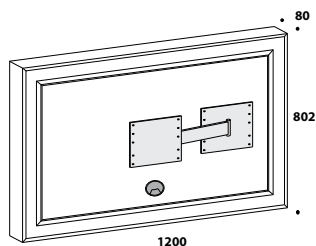

Angolazione massima: 30°
Maximum angle: 30°
Portata massima kg: 25
Maximum load: 25 kg

Z.876

595,00

SCHIENALE PORTA TV ORIENTABILE IN APPOGGIO L. 1200 P. 80 H. 932

ADJUSTABLE ELEMENT FOR
TELEVISION LEANING ON BASE
MODULE
W. 1200 D. 80 H. 932

Dotazione:

- Schienale sp. 80
- Meccanismo orientabile
- Foro con tappo passacavi
- Pannello inferiore copricavi

Equipment:

- Hanging panel th. 80
- Adjustable system
- Round cable hole plug
- Lower panel for cable cover

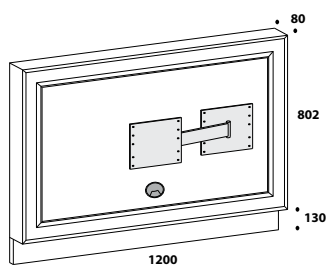

Angolazione massima: 30°
Maximum angle: 30°
Portata massima kg: 25
Maximum load: 25 kg

Z.877

680,00

ELEMENTI PENSILI L. 600/1200

HANGING MODULES W. 600/1200

H. 401
P. D. 350

- Vetri disponibili: trasparente, riflettente
- Glass available: transparent, reflecting
- Elementi comprensivi di attaccaglie
- Equipped with wall hooks

Codice
Code

Laccato, Laccato consumato, Frassino tinto,
Frassino laccato opaco, Frassino decapè
lacquered, "Consumato" laquered, Stained ash-wood,
Ash-wood matt lacquered, Ash-wood "decapè"

1 ANTA LEGNO L. 600
1 WOODEN DOOR W. 600

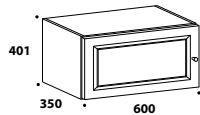

Z.005

253,00

1 ANTA VETRO L. 600
1 GLASS DOOR W. 600

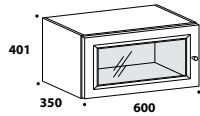

Z.003

308,00

2 ANTE LEGNO L. 1200
2 WOODEN DOORS W. 1200

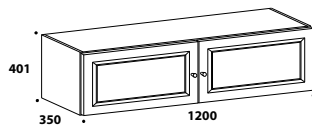

Z.201

381,00

2 ANTE VETRO L. 1200
2 GLASS DOORS W. 1200

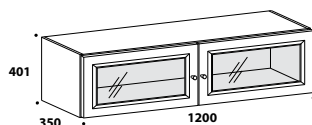

Z.203

491,00

ELEMENTI PENSILI L. 600/1200

HANGING MODULES W. 600/1200

H. 601
P. D. **350**

- Vetri disponibili: trasparente, riflettente
- Glass available: transparent, reflecting
- Elementi comprensivi di attaccaglie
- Equipped with wall hooks

Codice
Code

Laccato, Laccato consumato, Frassino tinto,
Frassino laccato opaco, Frassino decapè
lacquered, "Consumato" laquered, Stained ash-wood,
Ash-wood matt lacquered, Ash-wood "decapè"

1 ANTA LEGNO L. 600
1 WOODEN DOOR W. 600

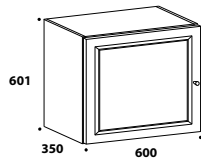

Maggiorazione per decoro flower: € 60,00 (caduna)
Surcharge for flower decoration: € 60,00 (each)

Z.024

308,00

1 ANTA VETRO L. 600
1 GLASS DOOR W. 600

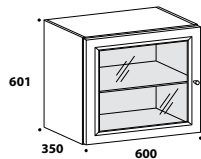

Maggiorazione per frontale vetro con inglesina: € 22,00 (caduna)
Surcharge for glass door with grating: € 22,00 (each)

Z.025

368,00

2 ANTE LEGNO L. 1200
2 WOODEN DOORS W. 1200

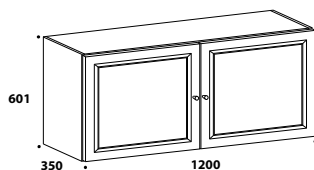

Maggiorazione per decoro flower: € 60,00 (caduna)
Surcharge for flower decoration: € 60,00 (each)

Z.226

511,00

2 ANTE VETRO L. 1200
2 GLASS DOORS W. 1200

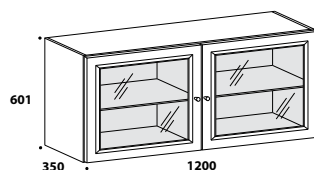

Maggiorazione per frontale vetro con inglesina: € 22,00 (caduna)
Surcharge for glass door with grating: € 22,00 (each)

Z.227

631,00

ELEMENTI PENSILI L. 600/1200

HANGING MUDULES W. 600/1200

H. 802

P. D. **350**

- Vetri disponibili: trasparente, riflettente
- Glass available: transparent, reflecting
- Elementi comprensivi di attaccaglie
- Equipped with wall hooks

Codice
Code

Laccato, Laccato consumato, Frassino tinto,
Frassino laccato opaco, Frassino decapè
lacquered, "Consumato" laquered, Stained ash-wood,
Ash-wood matt lacquered, Ash-wood "decapè"

2 ANTE LEGNO L. 600 H. 802
2 WOODEN DOORS W. 600 H. 802

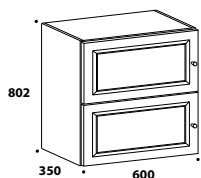

Z.018

377,00

1 ANTA LEGNO + 1 ANTA VETRO L. 600 H. 802
1 WOODEN DOOR + 1 GLASS DOOR
W. 600 H. 802

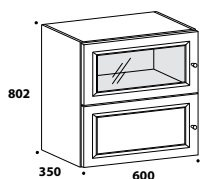

Z.01801

432,00

2 ANTE VETRO L. 600 H. 802
2 GLASS DOORS W. 600 H. 802

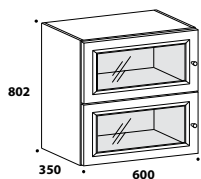

Z.01802

487,00

4 ANTE LEGNO L. 1200 H. 802
4 WOODEN DOORS W. 1200 H. 802

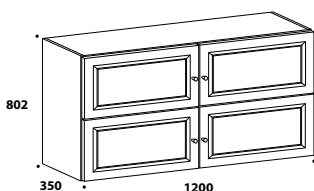

Z.21801

578,00

ELEMENTI PENSILI L. 600/1200

HANGING MUDULES W. 600/1200

H. 802/1203

P. D. 350

- Vetri disponibili: trasparente, riflettente
- Glass available: transparent, reflecting
- Elementi comprensivi di attaccaglie
- Equipped with wall hooks

Codice
Code

Laccato, Laccato consumato, Frassino tinto,
Frassino laccato opaco, Frassino decapè
lacquered, "Consumato" laquered, Stained ash-wood,
Ash-wood matt lacquered, Ash-wood "decapè"

2 ANTE LEGNO + 2 ANTE VETRO L. 1200 H. 802

2 WOODEN DOORS + 2 GLASS
DOORS W. 1200 H. 802

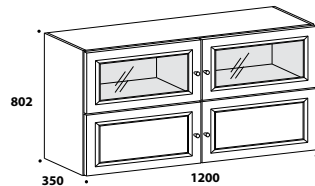

Z.21802

688,00

4 ANTE VETRO L. 1200 H. 802

4 GLASS DOORS W. 1200 H. 802

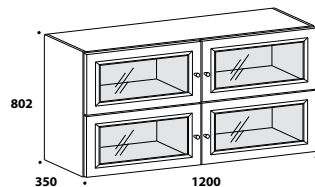

Z.21901

798,00

2 ANTE LEGNO L. 600

2 WOODEN DOORS W. 600

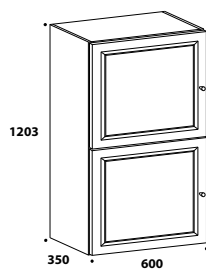

Z.026

484,00

Maggiorazione per decoro flower: € 60,00 (caduna)
Surcharge for flower decoration: € 60,00 (each)

1 ANTA LEGNO + 1 ANTA VETRO L. 600

1 WOODEN DOOR + 1 GLASS DOOR
W. 600

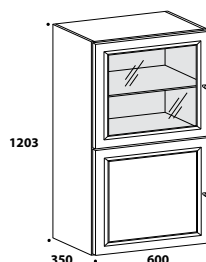

Z.02602

544,00

Maggiorazione per frontale vetro con inglesina: € 22,00 (caduna)
Surcharge for glass door with grating: € 22,00 (each)

Maggiorazione per decoro flower: € 60,00 (caduna)
Surcharge for flower decoration: € 60,00 (each)

ELEMENTI PENSILI L. 1200

HANGING MODULES W. 1200

H. 1203
P. D. **350**

- Vetri disponibili: trasparente, riflettente
- Glass available: transparent, reflecting
- Elementi comprensivi di attaccaglie
- Equipped with wall hooks

Codice
Code

Laccato, Laccato consumato, Frassino tinto,
Frassino laccato opaco, Frassino decapè
lacquered, "Consumato" laquered, Stained ash-wood,
Ash-wood matt lacquered, Ash-wood "decapè"

2 ANTE VETRO L. 600

2 GLASS DOORS W. 600

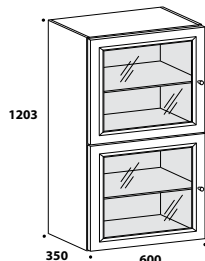

Maggiorazione per frontale vetro con inglesina: € 22,00 (caduna)
Surcharge for glass door with grating: € 22,00 (each)

Z.02601

604,00

4 ANTE LEGNO L. 1200

4 WOODEN DOORS W. 1200

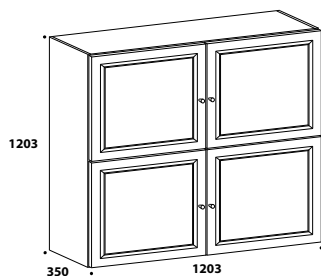

Maggiorazione per decoro flower: € 60,00 (caduna)
Surcharge for flower decoration: € 60,00 (each)

Z.230

836,00

2 ANTE LEGNO + 2 ANTE VETRO L. 1200 H. 1203

2 WOODEN DOORS + 2 GLASS DOORS W. 1200 H. 1203

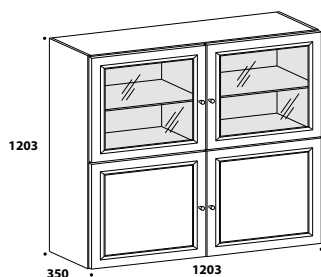

Maggiorazione per frontale vetro con inglesina: € 22,00 (caduna)
Surcharge for glass door with grating: € 22,00 (each)
Maggiorazione per decoro flower: € 60,00 (caduna)
Surcharge for flower decoration: € 60,00 (each)

Z.23002

956,00

4 ANTE VETRO L. 1200 H. 1203

4 GLASS DOORS W. 1200 H. 1203

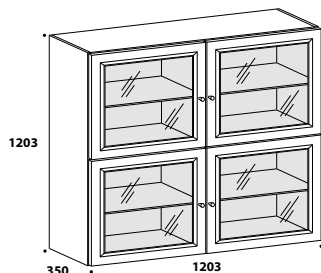

Maggiorazione per frontale vetro con inglesina: € 22,00 (caduna)
Surcharge for glass door with grating: € 22,00 (each)

Z.23001

1.076,00

ELEMENTI PENSILI

HANGING MODULES

P. D. **350**

- Vetri disponibili: trasparente, riflettente
- Glass available: transparent, reflecting
- Elementi comprensivi di attaccaglie
- Equipped with wall hooks

Codice
Code

Laccato, Laccato consumato, Frassino tinto,
Frassino laccato opaco, Frassino decapè
lacquered, "Consumato" laquered, Stained ash-wood,
Ash-wood matt lacquered, Ash-wood "decapè"

1 ANTA LEGNO L. 900 H. 802
1 WOODEN DOOR W. 900 H. 802

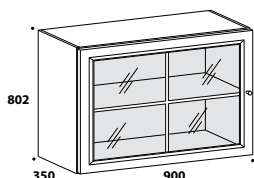

Z.066

503,00

1 ANTA LEGNO L. 400 H. 1203
1 WOODEN DOOR W. 400 H. 1203

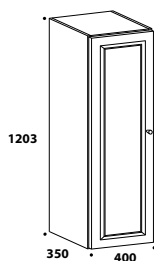

Z.048

373,00

1 ANTA VETRO L. 400 H. 1203
1 GLASS DOOR W. 400 H. 1203

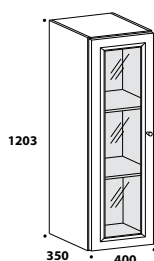

Z.054

443,00

ELEMENTI PENSILI RIBALTA

FLAP DOOR HANGING MODULES

H. 401
P. D. **350**

- Vetri disponibili: trasparente, riflettente
- Glass available: transparent, reflecting
- Elementi comprensivi di attaccaglie
- Equipped with wall hooks

Codice
Code

Laccato, Laccato consumato, Frassino tinto,
Frassino laccato opaco, Frassino decapè
lacquered, "Consumato" laquered, Stained ash-wood,
Ash-wood matt lacquered, Ash-wood "decapè"

1 ANTA LEGNO L. 900
1 WOODEN DOOR W. 900

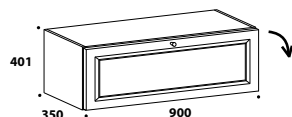

Z.247

363,00

1 ANTA LEGNO L. 1200
1 WOODEN DOOR W. 1200

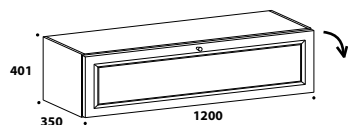

Z.252

438,00

1 ANTA VETRO L. 900
1 GLASS DOOR W. 900

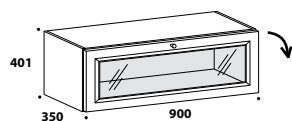

Z.245

423,00

1 ANTA VETRO L. 1200
1 GLASS DOOR W. 1200

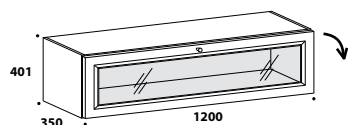

Z.250

508,00

ELEMENTI PENSILI VISISTAS

VASISTAS DOOR HANGING MODULES

H. 401
P. D. **350**

- Vetri disponibili: trasparente, riflettente
- Glass available: transparent, reflecting
- Elementi comprensivi di attaccaglie
- Equipped with wall hooks

Codice
Code

Laccato, Laccato consumato, Frassino tinto,
Frassino laccato opaco, Frassino decapè
lacquered, "Consumato" laquered, Stained ash-wood,
Ash-wood matt lacquered, Ash-wood "decapè"

1 ANTA LEGNO L. 900
1 WOODEN DOOR W. 900

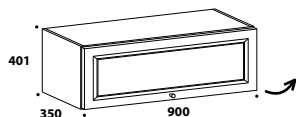

Z.248

363,00

1 ANTA LEGNO L. 1200
1 WOODEN DOOR W. 1200

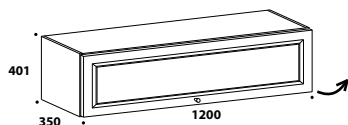

Z.253

438,00

1 ANTA VETRO L. 900
1 GLASS DOOR W. 900

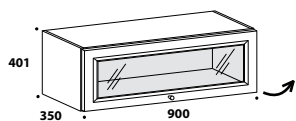

Z.246

423,00

1 ANTA VETRO L. 1200
1 GLASS DOOR W. 1200

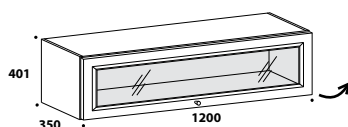

Z.251

508,00

ELEMENTI PENSILI "SCARABEO"

"SCARABEO" HANGING MODULES

H. 300
P. D. **348**

- Elementi comprensivi di attaccaglie
- Equipped with wall hooks

L. 900/1200/1800
W. 900/1200/1800

Struttura in legno sp. 12 mm
Structure Th. 12 mm

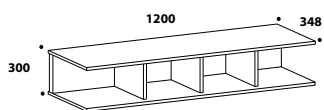
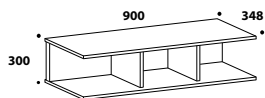

Tali elementi possono essere appesi in orizzontale o in verticale

These elements may be hung both vertically and horizontally

Orizzontale Verticale
Horizontal Vertical

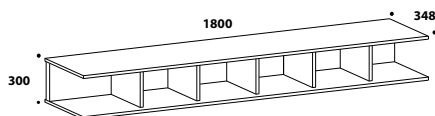
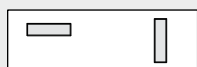

Codice
Code

Laccato, Laccato consumato, Frassino tinto,
Frassino laccato opaco, Frassino decapè
lacquered, "Consumato" laquered, Stained ash-wood,
Ash-wood matt lacquered, Ash-wood "decapè"

Z.117

281,00

Z.118

331,00

Z.119

381,00

TOP PER PENSILI

TOP FOR HANGING MODULES

P. D. **350**

Codice
Code

Laccato, Laccato consumato, Frassino tinto,
Frassino laccato opaco, Frassino decapè
lacquered, "Consumato" laquered, Stained ash-wood,
Ash-wood matt lacquered, Ash-wood "decapè"

TOP PER PENSILI prof. 350 mm sp. 12 mm

TOP FOR HANGING MODULES D. 350 mm
Th. 12 mm

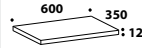

L. W. 600 mm

Z.691

46,00

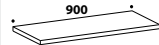

L. W. 900 mm

Z.692

59,00

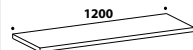

L. W. 1200 mm

Z.693

74,00

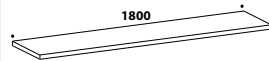

L. W. 1800 mm

Z.694

101,00

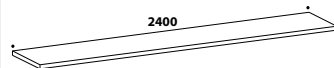

L. W. 2400 mm

Z.695

127,00

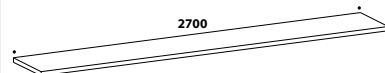

L. W. 2700 mm

Z.696

135,00

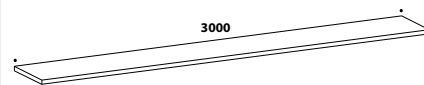

L. W. 3000 mm

Z.697

146,00

Taglio a misura € 36,00
Cost for cut € 36,00

TOP PER PENSILI prof. 350 mm sp. 26 mm

TOP FOR HANGING MODULES D. 350 mm
Th. 26 mm

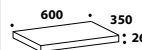

L. W. 600

Z.700T

50,00

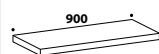

L. W. 900

Z.702T

78,00

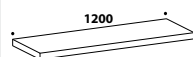

L. W. 1200

Z.722T

94,00

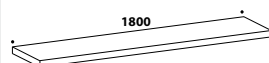

L. W. 1800

Z.703T

111,00

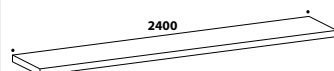

L. W. 2400

Z.725T

143,00

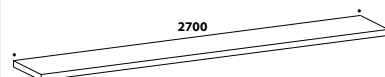

L. W. 2700

Z.719T

173,00

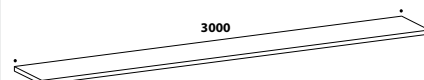

L. W. 3000

Z.729T

198,00

Taglio a misura € 36,00
Cost for cut € 36,00

TOP PER BASI

TOP FOR BASE MODULES

P. D. **450**

Codice
Code

Laccato, Laccato consumato, Frassino tinto,
Frassino laccato opaco, Frassino decapè
lacquered, "Consumato" lacquered, Stained ash-wood,
Ash-wood matt lacquered, Ash-wood "decapè"

TOP PER BASI prof. 450 mm
sp. 12 mm
L. 600 P. 450 Sp. 12
TOP FOR BASE MODULES D. 450 mm
Th. 12 mm
W. 600 D. 450 Th. 12

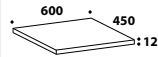

L. W. 600 mm

Z.511

47,00

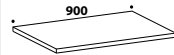

L. W. 900 mm

Z.513

75,00

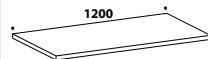

L. W. 1200 mm

Z.535

90,00

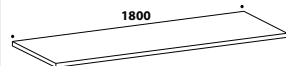

L. W. 1800 mm

Z.516

141,00

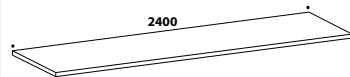

L. W. 2400 mm

Z.538

187,00

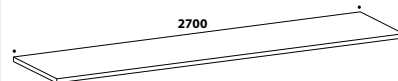

L. W. 2700 mm

Z.519

217,00

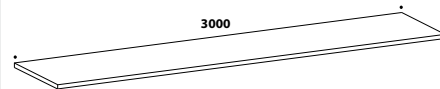

L. W. 3000 mm

Z.541

227,00

Taglio a misura € 36,00
Cost for cut € 36,00

TOP PER BASI prof. 450 mm
sp. 26 mm
TOP FOR BASE MODULES D. 450 mm
Th. 26 mm

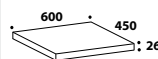

L. W. 600 mm

Z.510

52,00

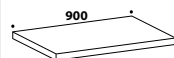

L. W. 900 mm

Z.512

81,00

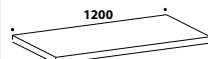

L. W. 1200 mm

Z.534

99,00

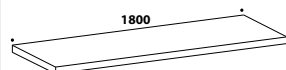

L. W. 1800 mm

Z.515

150,00

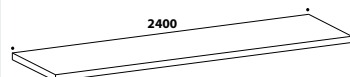

L. W. 2400 mm

Z.537

199,00

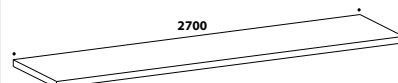

L. W. 2700 mm

Z.518

233,00

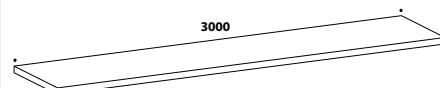

L. W. 3000 mm

Z.540

249,00

Taglio a misura € 36,00
Cost for cut € 36,00

TOP PER BASI

TOP FOR BASE MODULES

P. D. **600**

Codice
Code

Laccato, Laccato consumato, Frassino tinto,
Frassino laccato opaco, Frassino decapè
lacquered, "Consumato" laquered, Stained ash-wood,
Ash-wood matt lacquered, Ash-wood "decapè"

TOP PER BASI prof. 600 mm
sp. 12 mm
TOP FOR BASE MODULES D. 600
mm Th. 12 mm

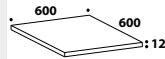

L. W. 600 mm

Z.501

47,00

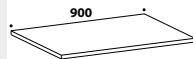

L. W. 900 mm

Z.508

75,00

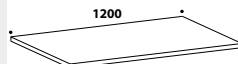

L. W. 1200 mm

Z.525

90,00

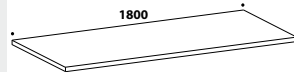

L. W. 1800 mm

Z.506

141,00

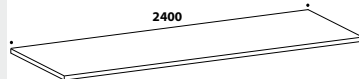

L. W. 2400 mm

Z.526

187,00

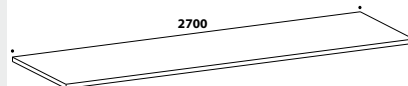

L. W. 2700 mm

Z.529

217,00

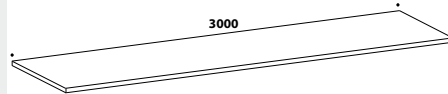

L. W. 3000 mm

Z.531

227,00

Taglio a misura € 36,00
Cost for cut € 36,00

TOP PER BASI prof. 600 mm
sp. 26 mm
TOP FOR BASE MODULES D. 600 mm
Th. 26 mm

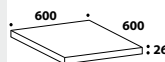

L. W. 600 mm

Z.500

52,00

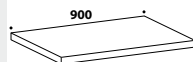

L. W. 900 mm

Z.507

81,00

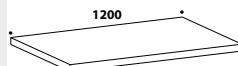

L. W. 1200 mm

Z.524

99,00

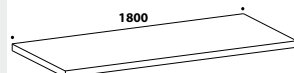

L. W. 1800 mm

Z.505

150,00

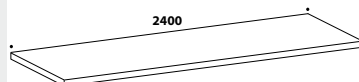

L. W. 2400 mm

Z.527

199,00

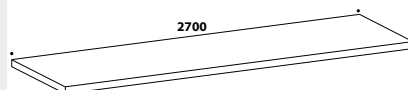

L. W. 2700 mm

Z.528

233,00

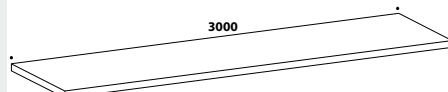

L. W. 3000 mm

Z.530

249,00

Taglio a misura € 36,00
Cost for cut € 36,00

Codice
Code

Laccato, Laccato consumato, Frassino tinto,
Frassino laccato opaco, Frassino decapè
lacquered, "Consumato" laquered, Stained ash-wood,
Ash-wood matt lacquered, Ash-wood "decapè"

P. 280 Sp. 30
D. 280 Th. 30

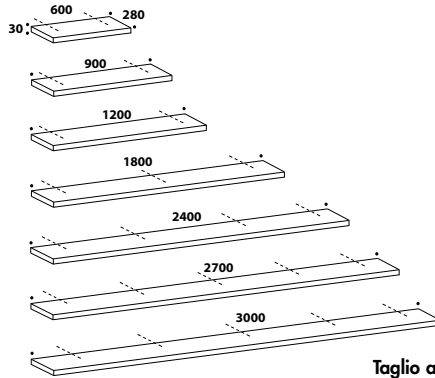

L. W. 600 mm

Z.700

50,00

L. W. 900 mm

Z.702

78,00

L. W. 1200 mm

Z.722

94,00

L. W. 1800 mm

Z.703

111,00

L. W. 2400 mm

Z.725

143,00

L. W. 2700 mm

Z.719

173,00

L. W. 3000 mm

Z.729

198,00

Taglio a misura € 36,00
Cost for cut € 36,00

P. 280 Sp. 51
D. 280 Th. 51

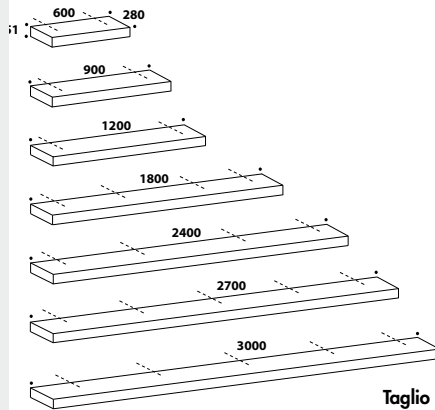

L. W. 600 mm

Z.716

87,00

L. W. 900 mm

Z.717

101,00

L. W. 1200 mm

Z.720

116,00

L. W. 1800 mm

Z.706

164,00

L. W. 2400 mm

Z.728

226,00

L. W. 2700 mm

Z.721

255,00

L. W. 3000 mm

Z.718

285,00

Taglio a misura € 36,00
Cost for cut € 36,00

**SUPPORTI A SCOMPARSA PER
MENSOLE A MURO**
CONCEALED SUPPORTS FOR WALL-
MOUNTED SHELVES

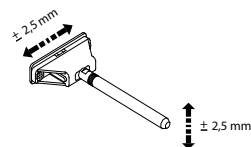

Regolabile

Y.714

9,00

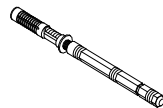

Non regolabile

Y.711

9,00

**SUPPORTI A SCOMPARSA PER
MENSOLE SU SCHIENE**
CONCEALED SUPPORTS FOR SHELVES
ON BACK PANELS

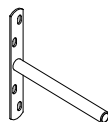

Y.710

9,00

MENSOLE SPECIALI

SPECIAL SHELVES

H. 427
P. D. **280**

- Elementi comprensivi di ferramenta per fissaggio a muro
- Equipped with hardware for fixing to wall

Codice
Code

Laccato, Laccato consumato, Frassino tinto,
Frassino laccato opaco, Frassino decapè
lacquered, "Consumato" laquered, Stained ash-wood,
Ash-wood matt lacquered, Ash-wood "decapè"

MENSOLA SPECIALE L. 1800

SPECIAL SHELVES W. 1800

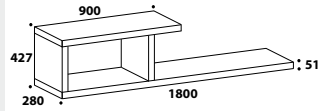

Sinistra basso L. 1800
Bottom left W. 1800

Z.836

397,00

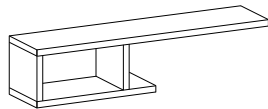

Sinistra alto L. 1800
Top left W. 1800

Z.736

397,00

MENSOLA SPECIALE L. 1800

SPECIAL SHELVES W. 1800

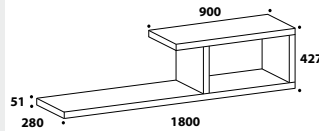

Destra basso L. 1800
Bottom right W. 1800

Z.738

397,00

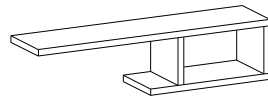

Destra alto L. 1800
Top right W. 1800

Z.838

397,00

MENSOLA SPECIALE L. 2400

SPECIAL SHELVES W. 2400

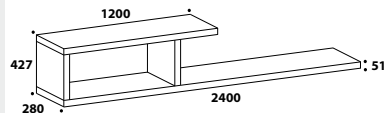

Sinistra basso L. 2400
Bottom left W. 2400

Z.832

495,00

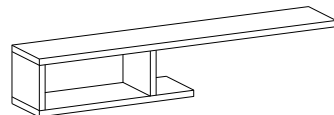

Sinistra alto L. 2400
Top left W. 2400

Z.739

495,00

MENSOLA SPECIALE L. 2400

SPECIAL SHELVES W. 2400

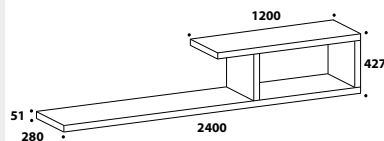

Destra basso L. 2400
Bottom right W. 2400

Z.740

495,00

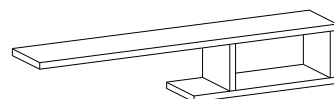

Destra alto L. 2400
Top right W. 2400

Z.833

495,00

SCHIENE ATTREZZATE

HANGING PANELS

Sp. Th. 26

- Elementi comprensivi di ferramenta per fissaggio a muro
- Equipped with hardware for fixing to wall
- Nella finitura frassino il senso vena è orizzontale
- Ash-wood finish panels always have horizontal vein

Codice
Code

Laccato, Laccato consumato, Frassino tinto,
Frassino laccato opaco, Frassino decapè
lacquered, "Consumato" laquered, Stained ash-wood,
Ash-wood matt lacquered, Ash-wood "decapè"

SCHIENE L. 1200

PANELS W. 1200

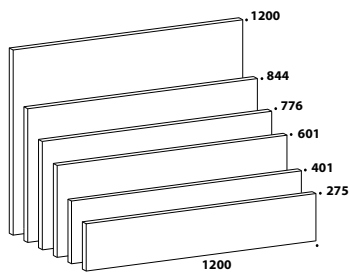

H. H. 1200 mm	Z.669	253,00
H. H. 844 mm	Z.668	166,00
H. H. 776 mm	Z.667	154,00
H. H. 601 mm	Z.677	143,00
H. H. 401 mm	Z.734	112,00
H. H. 275 mm	Z.663	105,00

Taglio a misura € 36,00
Cost for cut € 36,00

SCHIENE L. 1800

PANELS W. 1800

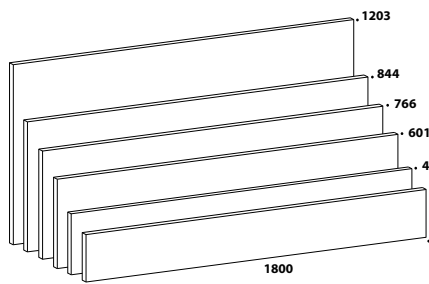

H. H. 1200 mm	Z.670	319,00
H. H. 844 mm	Z.656	264,00
H. H. 776 mm	Z.653	248,00
H. H. 601 mm	Z.659	198,00
H. H. 401 mm	Z.672	142,00
H. H. 275 mm	Z.664	121,00

Taglio a misura € 36,00
Cost for cut € 36,00

SCHIENE L. 2400

PANELS W. 2400

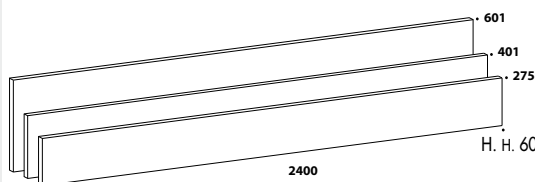

H. H. 601 mm	Z.671	253,00
H. H. 401 mm	Z.679	165,00
H. H. 275 mm	Z.666	132,00

Taglio a misura € 36,00
Cost for cut € 36,00

- Profondità struttura libreria 377 mm (frontali esclusi)
- Bookcase depth 377 (without frontals)

Codice
Code

Laccato, Laccato consumato, Frassino tinto,
Frassino laccato opaco, Frassino decapè
lacquered, "Consumato" laquered, Stained ash-wood,
Ash-wood matt lacquered, Ash-wood "decapè"

SPALLE STRUTTURALI Sp. 51

FLOOR-STANDING STRUCTURAL
SIDES Th. 51

Spalle complete di piedini
livellatori
Structural sides complete with levelling feet

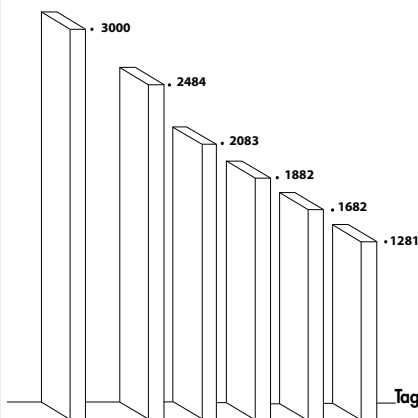
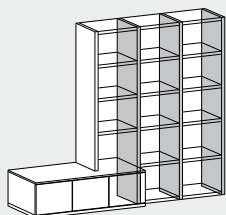

H. H. 3000 mm

Z.422G

246,00

H. H. 2484 mm

Z.421G

227,00

H. H. 2083 mm

Z.420G

198,00

H. H. 1882 mm

Z.419G

188,00

H. H. 1682 mm

Z.418G

175,00

H. H. 1281 mm

Z.414G

166,00

Taglio a misura € 36,00
Cost for cut € 36,00

SPALLE SOPRALZO

OVERLAP SIDES

Da sovrapporre a basi
sporgenti Sp. 51 mm
On protruding base modules Th. 51

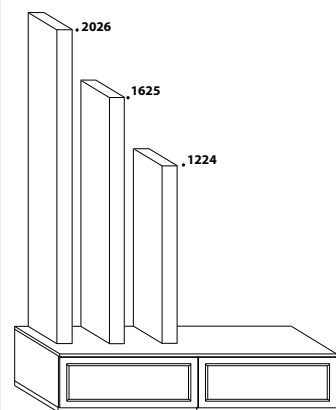
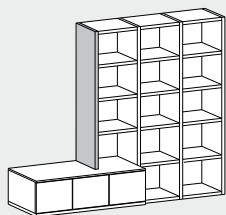

H. H. 2026 mm

Z.426G

190,00

H. H. 1625 mm

Z.425G

169,00

H. H. 1224 mm

Z.424G

155,00

Taglio a misura € 36,00
Cost for cut € 36,00

SPALLE DI SUPPORTO A TERRA CON PIEDINI LIVELLATORI Sp. 30

SUPPORTING SIDE TO FLOOR EQUIPPED
WITH LEVELLING FEET Th. 30

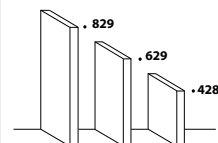
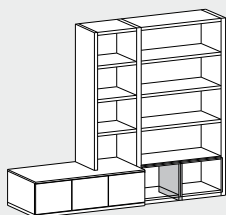

H. H. 829 mm

Z.436

83,00

H. H. 629 mm

Z.434

75,00

H. H. 428 mm

Z.435

66,00

Taglio a misura € 36,00
Cost for cut € 36,00

RIPIANI STRUTTURALI Sp. 51

STRUCTURAL SHELVES Th. 51

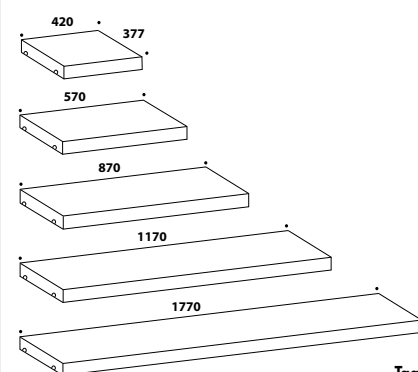
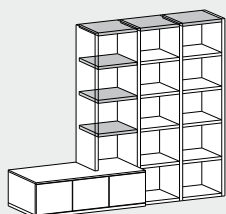

L. W. 420 mm

Z.450G

58,00

L. W. 570 mm

Z.451G

68,00

L. W. 870 mm

Z.452G

94,00

L. W. 1170 mm

Z.453G

113,00

L. W. 1770 mm

Z.454G

156,00

Taglio a misura € 36,00
Cost for cut € 36,00

RIPIANI E FONDI

SHELVES AND BOTTOMS

P. D. 362/377

Codice
Code

Laccato, Laccato consumato, Frassino tinto,
Frassino laccato opaco, Frassino decapè
lacquered, "Consumato" laquered, Stained ash-wood,
Ash-wood matt lacquered, Ash-wood "decapè"

RIPIANI STRUTTURALI RIDOTTI Sp. 51

REDUCED STRUCTURAL
SHELVES Th. 51

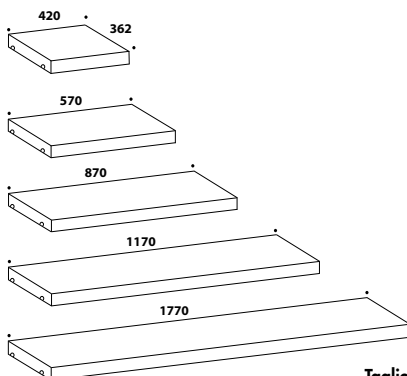
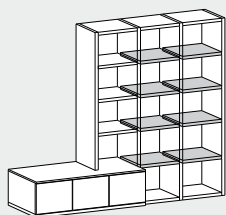

L. W. 420 mm	Z.450GR	58,00
L. W. 570 mm	Z.451GR	68,00
L. W. 870 mm	Z.452GR	94,00
L. W. 1170 mm	Z.453GR	113,00
L. W. 1770 mm	Z.454GR	156,00

Taglio a misura € 36,00
Cost for cut € 36,00

RIPIANI INTERNI VETRO

INTERNAL GLASS SHELVES

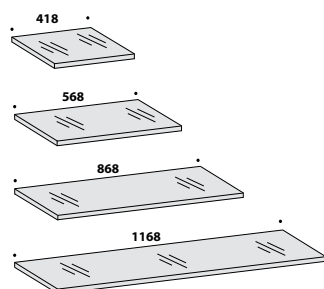

L. W. 418 mm	Z.760	16,00
L. W. 568 mm	Z.761	21,00
L. W. 868 mm	Z.762	29,00
L. W. 1168 mm	Z.763	39,00

FONDI Sp. 57

BOTTOMS Th. 57

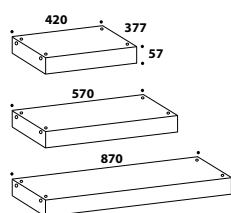
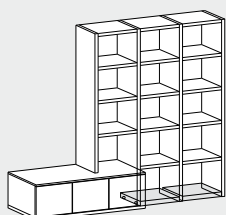

L. W. 420 mm	Z.446	50,00
L. W. 570 mm	Z.447	54,00
L. W. 870 mm	Z.448	64,00

Taglio a misura € 36,00
Cost for cut € 36,00

Codice
Code

Laccato, Laccato consumato, Frassino tinto,
Frassino laccato opaco, Frassino decapé
lacquered, "Consumato" laquered, Stained ash-wood,
Ash-wood matt lacquered, Ash-wood "decapé"

SCHIENALI L. 420 BACK PANELS W. 420

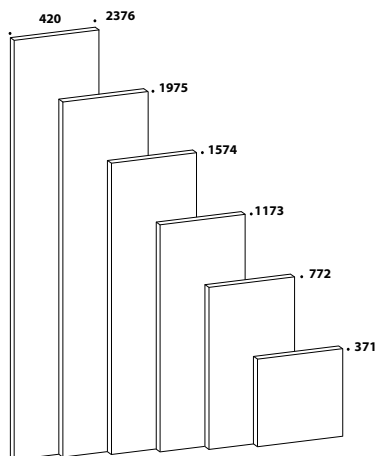

H. H. 2376 mm	Z.356	94,00
H. H. 1975 mm	Z.355	81,00
H. H. 1574 mm	Z.354	68,00
H. H. 1173 mm	Z.353	56,00
H. H. 772 mm	Z.352	43,00
H. H. 371 mm	Z.351	31,00

Taglio a misura € 36,00
Cost for cut € 36,00

SCHIENALI L. 570 BACK PANELS W. 570

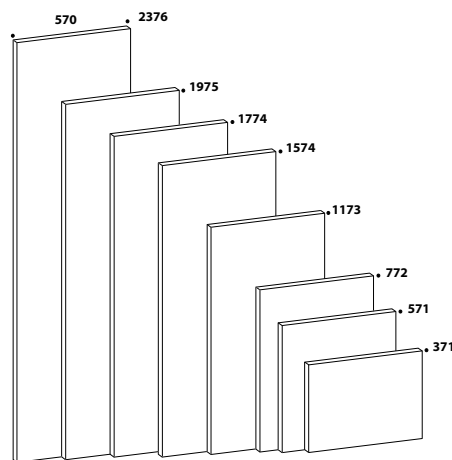

H. H. 2376 mm	Z.363	116,00
H. H. 1774 mm	Z.371	98,00
H. H. 1975 mm	Z.362	100,00
H. H. 1574 mm	Z.361	83,00
H. H. 1173 mm	Z.360	65,00
H. H. 772 mm	Z.359	51,00
H. H. 572 mm	Z.357	43,00
H. H. 371 mm	Z.358	33,00

Taglio a misura € 36,00
Cost for cut € 36,00

SCHIENALI L. 870 BACK PANELS W. 870

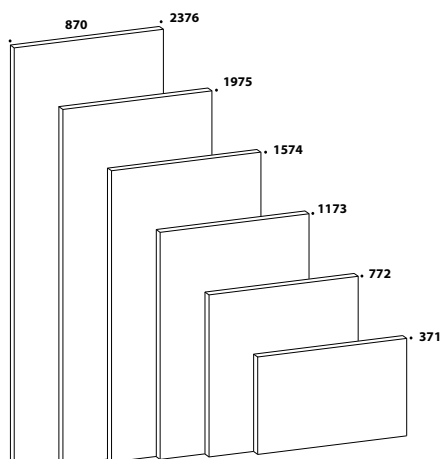

H. H. 2376 mm	Z.370	163,00
H. H. 1975 mm	Z.369	139,00
H. H. 1574 mm	Z.368	116,00
H. H. 1173 mm	Z.367	92,00
H. H. 772 mm	Z.366	63,00
H. H. 371 mm	Z.365	44,00

Taglio a misura € 36,00
Cost for cut € 36,00

Codice
Code

Laccato, Laccato consumato, Frassino tinto,
Frassino laccato opaco, Frassino decapé
lacquered, "Consumato" laquered, Stained ash-wood,
Ash-wood matt lacquered, Ash-wood "decapé"

SCHIENALI L. 1170 BACK PANELS W. 1170

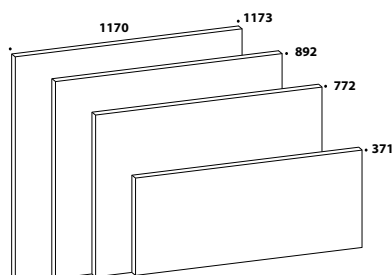

H. H. 1173 mm	Z.374	121,00
H. H. 892 mm	Z.375	116,00
H. H. 772 mm	Z.373	92,00
H. H. 371 mm	Z.372	57,00

Taglio a misura € 36,00
Cost for cut € 36,00

SCHIENALI L. 1770 BACK PANELS W. 1770

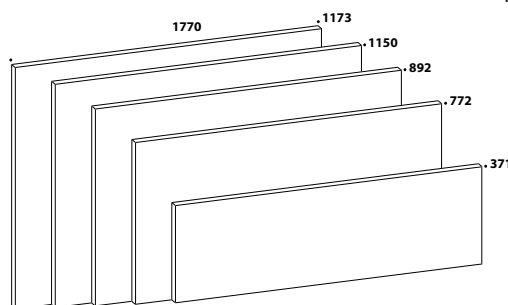

H. H. 1173 mm	Z.378	166,00
H. H. 1150 mm	Z.364	160,00
H. H. 892 mm	Z.379	151,00
H. H. 772 mm	Z.377	123,00
H. H. 371 mm	Z.376	76,00

Taglio a misura € 36,00
Cost for cut € 36,00

BARRA DI SUPPORTO SUPPORTING BAR

Da utilizzare su vani libreria senza tramezza di sostegno

To be used in bookcases's space without
supporting partitions

Elementi completi di fascetta frontale in legno

Equipped with frontal wooden band

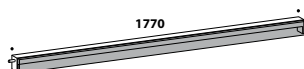
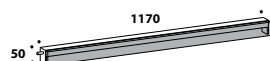

Per vano:
For width:

L. W. 1170 mm	X.815	51,00
L. W. 1770 mm	X.816	60,00

FRONTALI DOORS

- Vetri disponibili: trasparente, riflettente
- Glass available: transparent, reflecting

Codice
Code

Laccato, laccato consumato, Frassino tinto,
Frassino laccato opaco, Frassino decapè
lacquered, "Consumato" laquered, Stained ash-wood,
Ash-wood matt lacquered, Ash-wood "decapè"

ANTE LEGNO (PER MODULO L. 600)
WOODEN DOORS (FOR WIDTH W. 600)

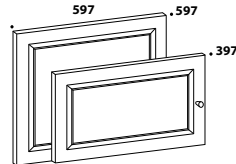

H. H. 597 mm

Z.320

114,00

H. H. 398 mm

Z.321

89,00

Maggiorazione per decoro flower: € 60,00 (caduna)
Surcharge for flower decoration: € 60,00 (each)

ANTE VETRO (PER MODULO L. 600)
GLASS DOORS (FOR WIDTH W. 600)

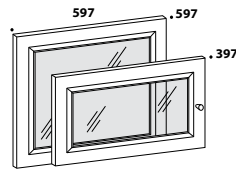

H. H. 597 mm

Z.340

174,00

H. H. 398 mm

Z.341

144,00

Maggiorazione per inglesina su anta 597x597: € 22,00
Surcharge for glass door with grating 597x597: € 22,00

ANTA VETRO (PER MODULO L. 900)
GLASS DOOR (FOR WIDTH W. 900)

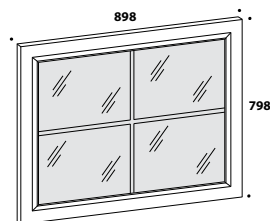

H. H. 798 mm

Z.326

290,00

CASSETTI DRAWER

Codice
Code

Laccato, Laccato consumato, Frassino tinto,
Frassino laccato opaco, Frassino decapè
lacquered, "Consumato" laquered, Stained ash-wood,
Ash-wood matt lacquered, Ash-wood "decapè"

1 CASSETTO H. 198 1 DRAWER H. 198

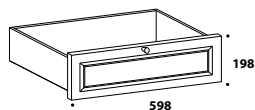

Per vano L. 570
For width W. 570

Z.548

126,00

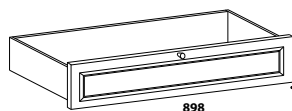

Per vano L. 870
For width W. 870

Z.549

141,00

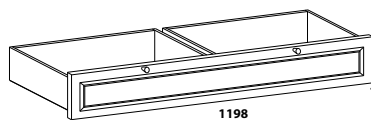

Per vano L. 1170
For width W. 1170

Z.557

180,00

2 CASSETTI H. 398 2 DRAWERS H. 398

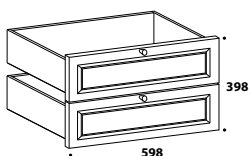

Per vano L. 570
For width W. 570

Z.348

245,00

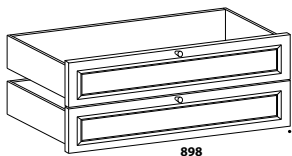

Per vano L. 870
For width W. 870

Z.349

273,00

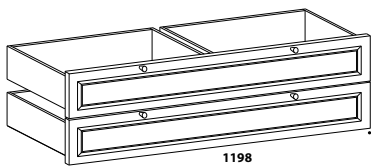

Per vano L. 1170
For width W. 1170

Z.346

341,00

1 CASSETTONE H. 398 1 HIGH DRAWER H. 398

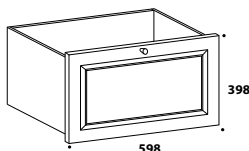

Per vano L. 570
For width W. 570

Z.328

194,00

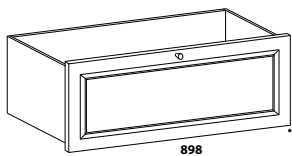

Per vano L. 870
For width W. 870

Z.329

230,00

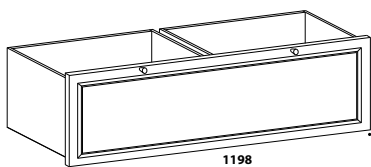

Per vano L. 1170
For width W. 1170

Z.399

306,00

ANTE RIBALTA

FLAP DOORS

H. 398

- Vetri disponibili: trasparente, riflettente
- Glass available: transparent, reflecting

Codice
Code

Laccato, Laccato consumato, Frassino finto,
Frassino laccato opaco, Frassino decapè
lacquered, "Consumato" laquered, Stained ash-wood,
Ash-wood matt lacquered, Ash-wood "decapè"

1 ANTA VETRO (PER MODULO L. 900)
1 GLASS DOOR (FOR WIDTH W. 900)

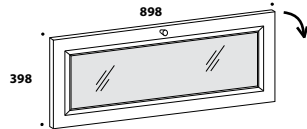

Z.403

259,00

1 ANTA LEGNO (PER MODULO L. 900)
1 WOODEN DOOR (FOR WIDTH W. 900)

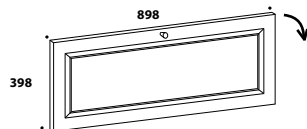

Z.388

199,00

1 ANTA VETRO (PER MODULO L. 1200)
1 GLASS DOOR (FOR WIDTH W. 1200)

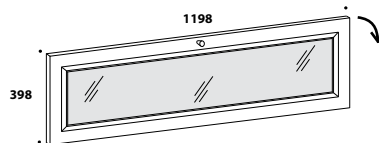

Z.395

291,00

1 ANTA LEGNO (PER MODULO L. 1200)
1 WOODEN DOOR (FOR WIDTH W. 1200)

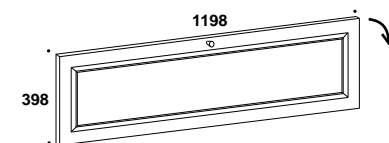

Z.428

221,00

- Vetri disponibili: trasparente, riflettente
- Glass available: transparent, reflecting

Codice
Code

Laccato, laccato consumato, Frassino tinto,
Frassino laccato opaco, Frassino decapè
lacquered, "Consumato" laquered, Stained ash-wood,
Ash-wood matt lacquered, Ash-wood "decapè"

1 ANTA VETRO PER MODULO L.900
1 GLASS DOOR FOR WIDTH W.900

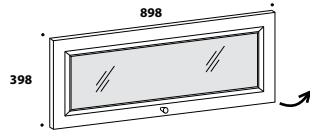

Z.404

259,00

1 ANTA LEGNO PER MODULO L.900
1 WOODEN DOOR FOR WIDTH W.900

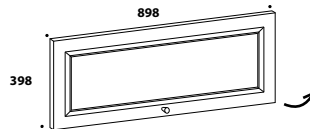

Z.389

199,00

1 ANTA VETRO PER MODULO L.1200
1 GLASS DOOR FOR WIDTH W.1200

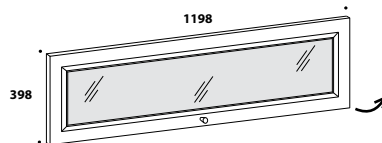

Z.396

291,00

1 ANTA LEGNO PER MODULO L.1200
1 WOODEN DOOR FOR WIDTH W.1200

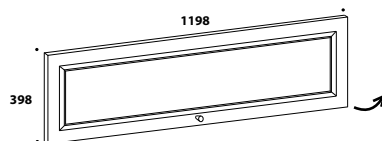

Z.429

221,00

COLONNE
BOOKCASE'S STRUCTURE

COLONNE A TERRA

STRUCTURE ON FLOOR

H. 2083
L. w. 621

Modulo L. 621
Width W. 621

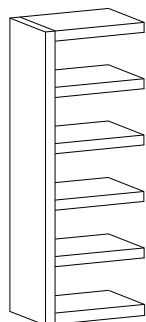
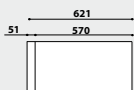

ZT.60501

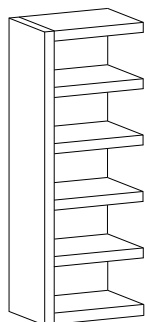

ZT.60502

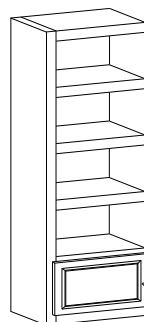

ZT.60503

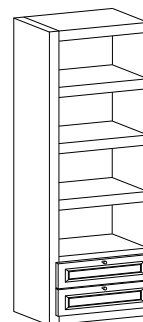

ZT.60504

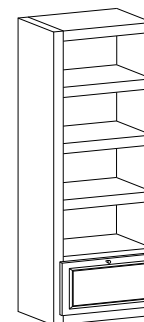

ZT.60505

Profondità **377**
Depth

592,00

692,00

781,00

937,00

886,00

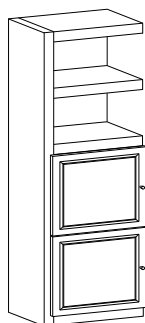

ZT.60506

894,00

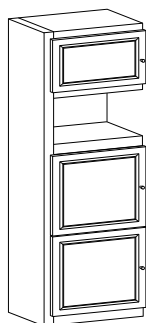

ZT.60507

983,00

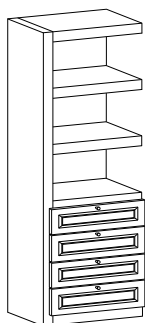

ZT.60508

1.165,00

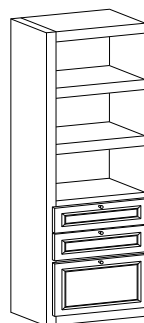

ZT.60509

1.114,00

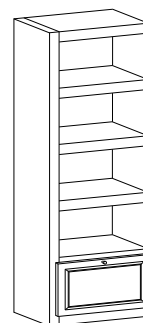

ZT.60510

1.254,00



ZT.60511

1.203,00

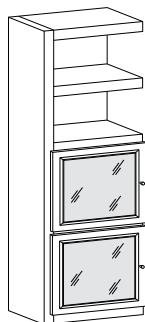

ZT.60512

1.014,00

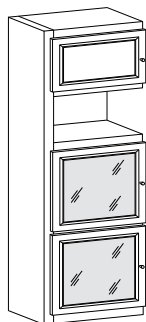

ZT.60513

1.103,00

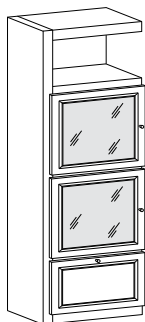

ZT.60514

1.208,00

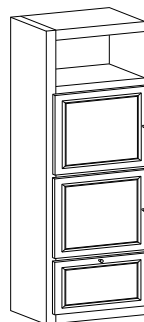

ZT.60515

1.088,00

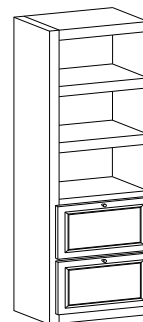

ZT.60516

1.063,00

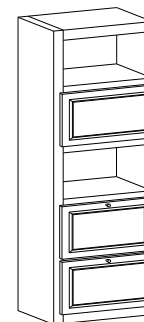

ZT.60517

1.152,00

COLONNE A TERRA

STRUCTURE ON FLOOR

H. 2484
L. w. 621

Modulo L. 621
Width W. 621

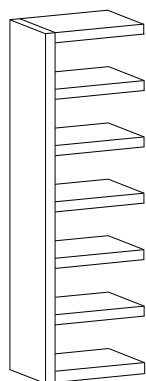
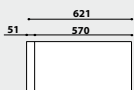

ZT.60601

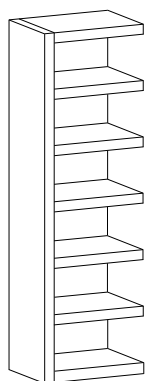

ZT.60602

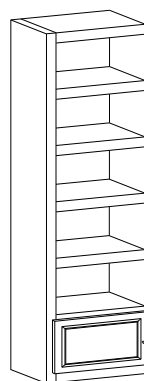

ZT.60603

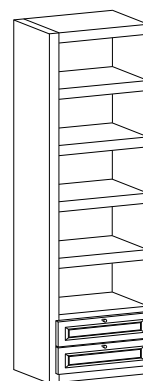

ZT.60604

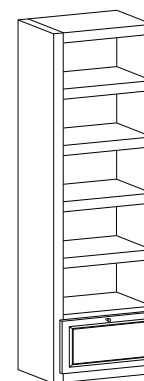

ZT.60605

Profondità
Depth

377

689,00

805,00

894,00

1.050,00

999,00

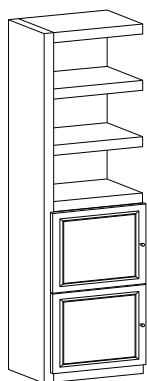

ZT.60606

1.007,00

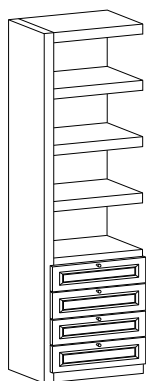

ZT.60607

1.278,00

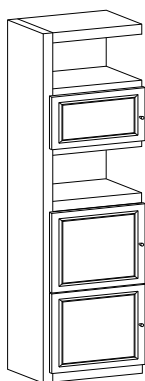

ZT.60608

1.096,00

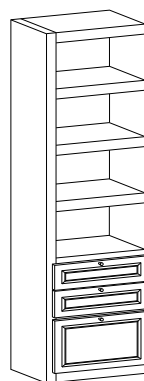

ZT.60609

1.227,00

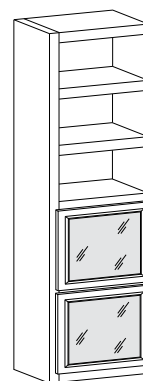

ZT.60610

1.127,00

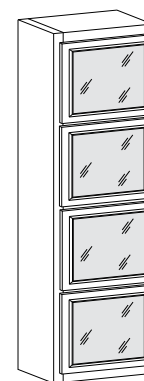

ZT.60611

1.449,00

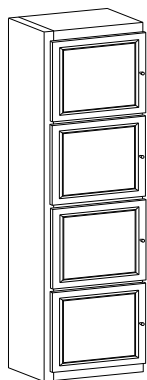

ZT.60612

1.209,00

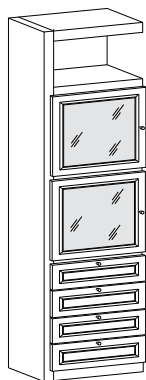

ZT.60613

1.600,00

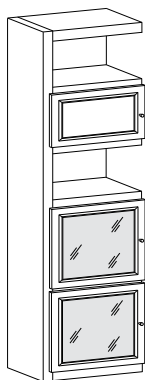

ZT.60614

1.305,00

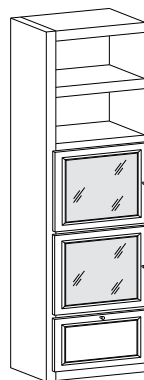

ZT.60615

1.515,00

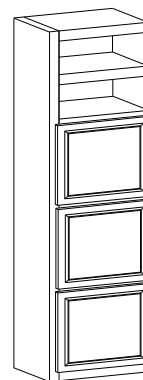

ZT.60616

1.142,00

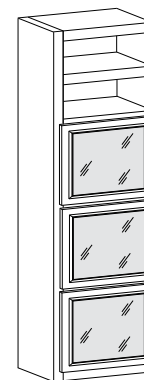

ZT.60617

1.322,00

COLONNE A TERRA

STRUCTURE ON FLOOR

H. 2083
L. w. 921

Modulo L. 921
Width W. 921

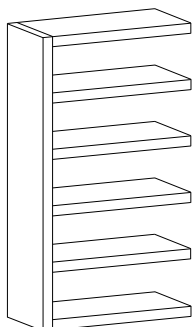
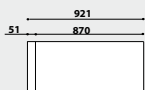

ZT.90501

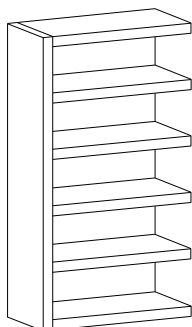

ZT.90502

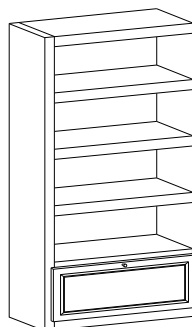

ZT.90503

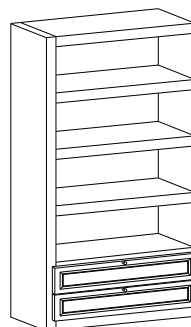

ZT.90504

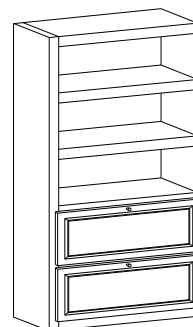

ZT.90505

Profondità
Depth

377

732,00

871,00

1.101,00

1.144,00

1.302,00

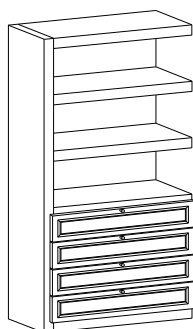

ZT.90506

1.388,00

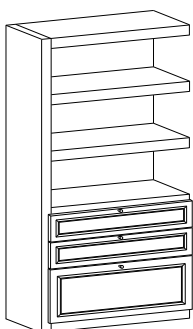

ZT.90507

1.345,00

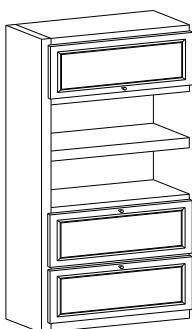

ZT.90508

1.501,00

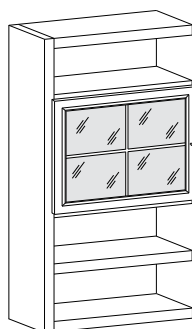

ZT.90509

1.190,00



ZT.90510

1.321,00

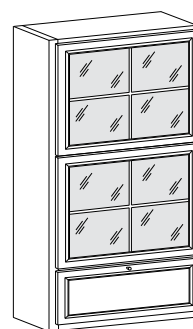

ZT.90511

1.551,00

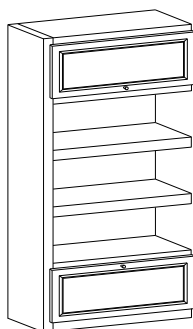

ZT.90512

1.300,00

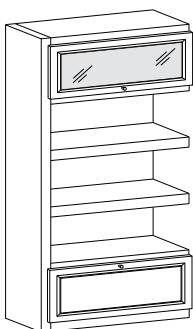

ZT.90513

1.360,00

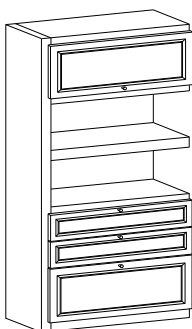

ZT.90514

1.544,00

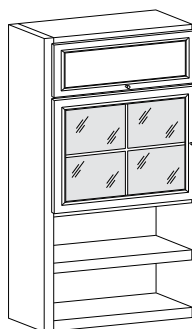

ZT.90515

1.295,00

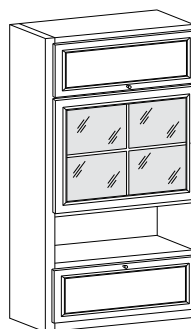

ZT.90516

1.525,00

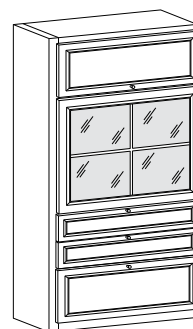

ZT.90517

1.769,00

COLONNE A TERRA

STRUCTURE ON FLOOR

H. 2484
L. w. 921

Modulo L. 921
Width W. 921

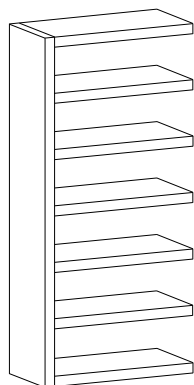
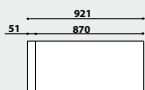

ZT.90601

855,00

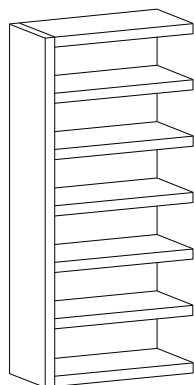

ZT.90602

1.018,00

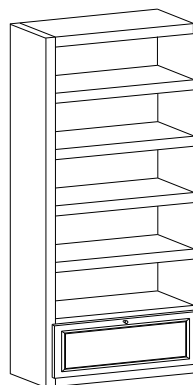

ZT.90603

1.248,00

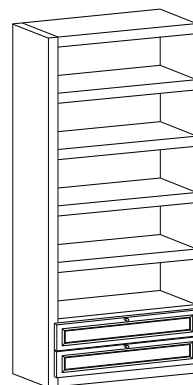

ZT.90604

1.291,00

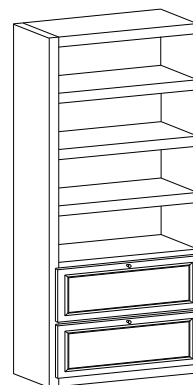

ZT.90605

1.449,00

Profondità
Depth

377

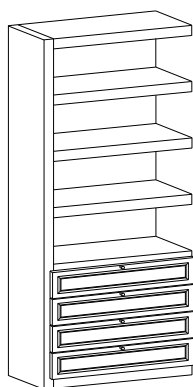

ZT.90606

1.535,00

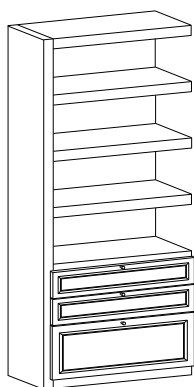

ZT.90607

1.492,00

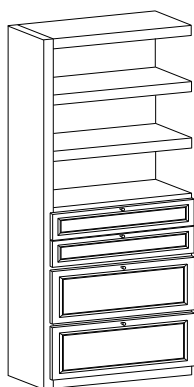

ZT.90608

1.693,00

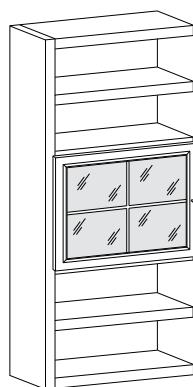

ZT.90609

1.243,00

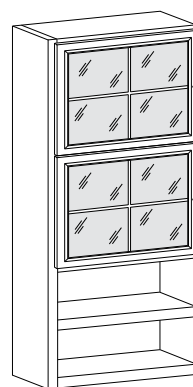

ZT.90610

1.468,00

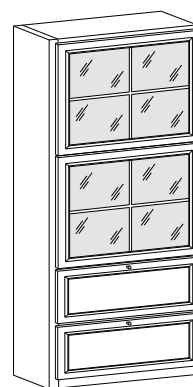

ZT.90611

1.899,00

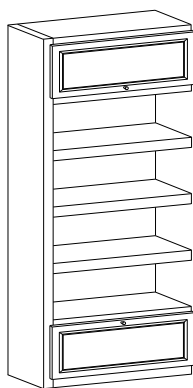

ZT.90612

1.447,00

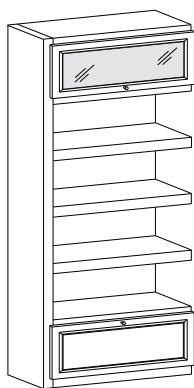

ZT.90613

1.507,00

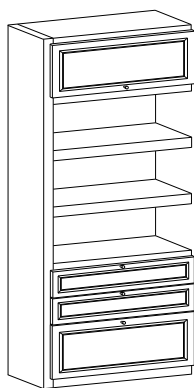

ZT.90614

1.691,00

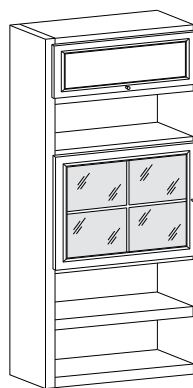

ZT.90615

1.442,00

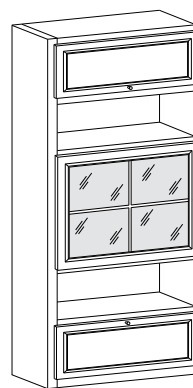

ZT.90616

1.672,00

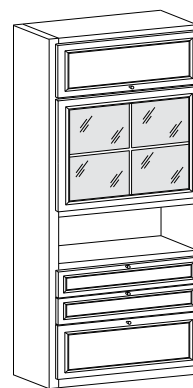

ZT.90617

1.916,00

COLONNE A SOPRALZO

OVERLAP STRUCTURE

H. 1625
L. w. 621

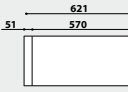
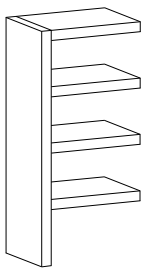
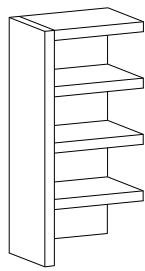
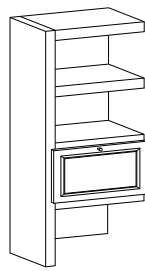
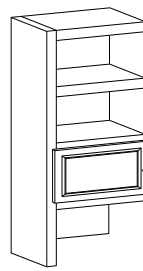
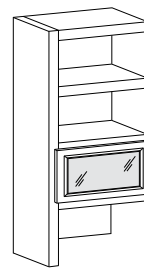
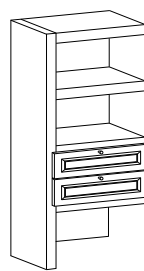
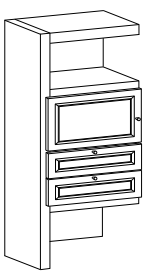
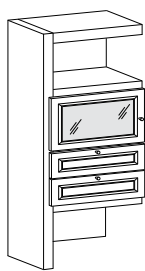
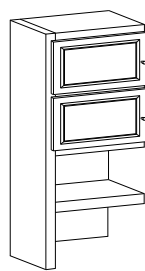
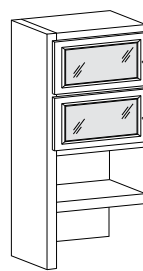
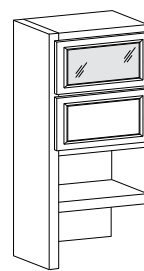
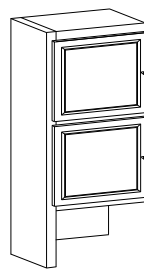
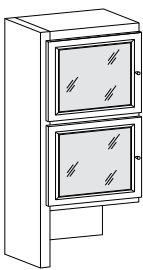
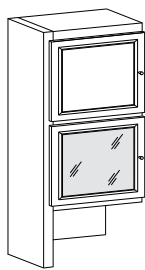
Modulo L. 621 Width W. 621							
							
		ZS.60401	ZS.60402	ZS.60403	ZS.60404	ZS.60405	
Profondità Depth	377	441,00	524,00	718,00	613,00	668,00	
							
		ZS.60406	ZS.60407	ZS.60408	ZS.60409	ZS.60410	ZS.60411
		769,00	858,00	913,00	702,00	812,00	757,00
							
		ZS.60412	ZS.60413	ZS.60414			
		726,00	846,00	786,00			

COLONNE A SOPRALZO

OVERLAP STRUCTURE

H. 2026
L. w. **621**

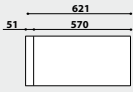
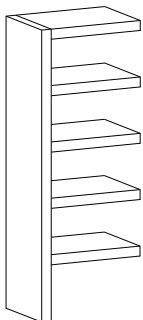
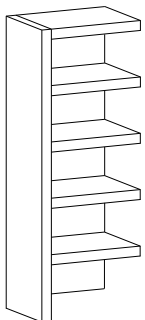
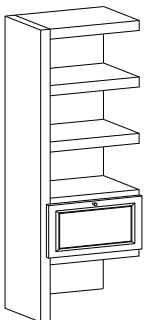
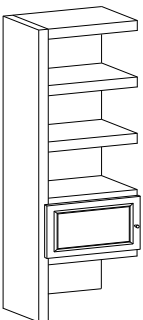
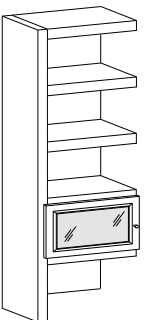
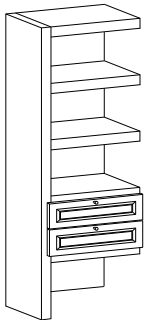
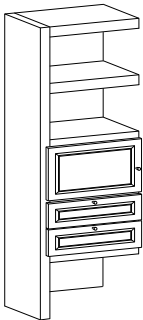
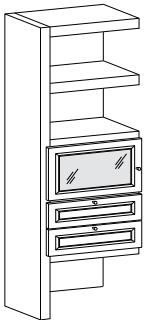
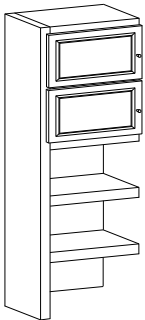
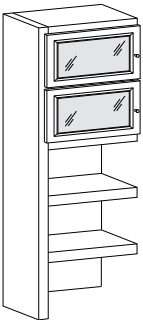
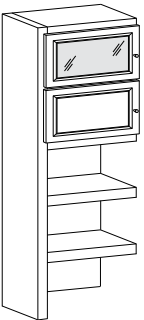
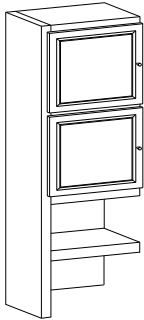
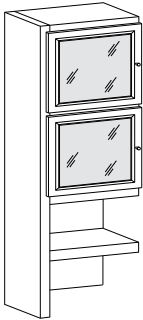
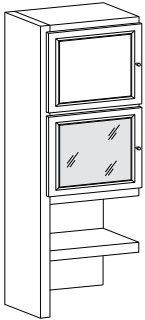
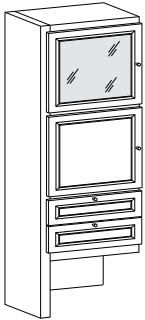
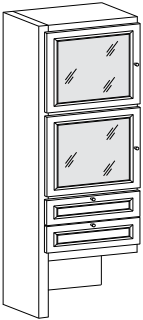
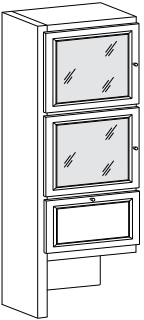
<p>Modulo L. 621 Width W. 621</p> 					
<p>Profondità Depth 377</p>	<p>ZS.60501 530,00</p>	<p>ZS.60502 630,00</p>	<p>ZS.60503 824,00</p>	<p>ZS.60504 719,00</p>	<p>ZS.60505 774,00</p>
					
<p>ZS.60506 875,00</p>	<p>ZS.60507 964,00</p>	<p>ZS.60508 1.019,00</p>	<p>ZS.60509 808,00</p>	<p>ZS.60510 918,00</p>	<p>ZS.60511 863,00</p>
					
<p>ZS.60512 832,00</p>	<p>ZS.60513 952,00</p>	<p>ZS.60514 892,00</p>	<p>ZS.60515 1.137,00</p>	<p>ZS.60516 1.197,00</p>	<p>ZS.60517 1.146,00</p>

COLONNE A SOPRALZO

OVERLAP STRUCTURE



H. 1625
L. w. 921

Modulo L. 921 Width W. 921						
		ZS.90401	ZS.90402	ZS.90403	ZS.90404	ZS.90405
Profondità Depth	377	545,00	661,00	891,00	934,00	860,00
		ZS.90406	ZS.90407	ZS.90408	ZS.90409	ZS.90410
		920,00	1.133,00	1.193,00	1.090,00	1.150,00
		ZS.90411				
		886,00				
		ZS.90412	ZS.90413			
		1.159,00	1.116,00			

COLONNE A SOPRALZO

OVERLAP STRUCTURE

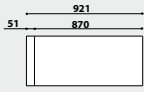
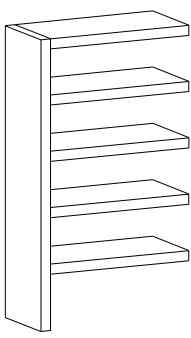
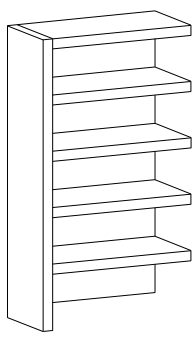
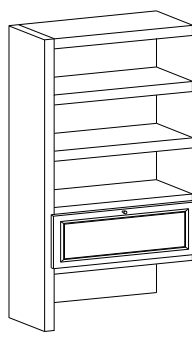
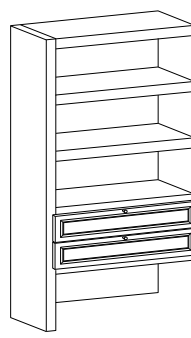
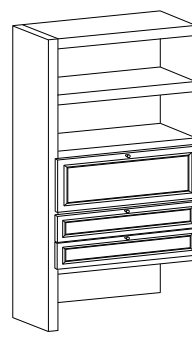
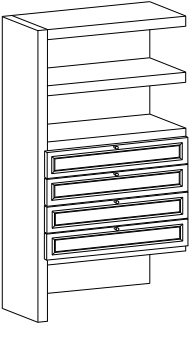
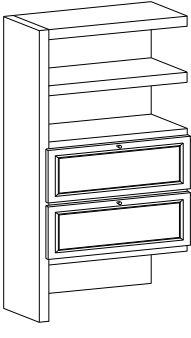
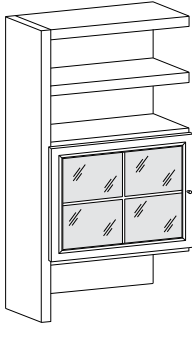
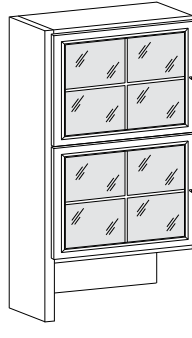
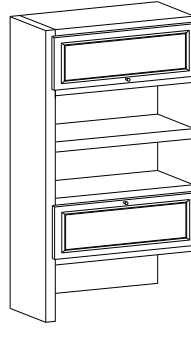
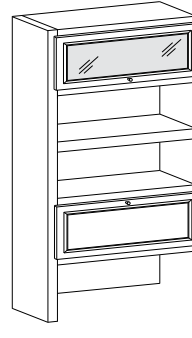
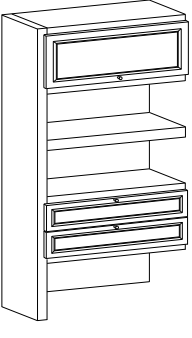
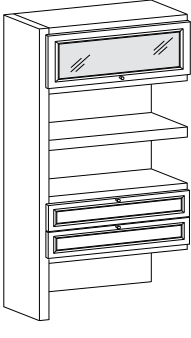
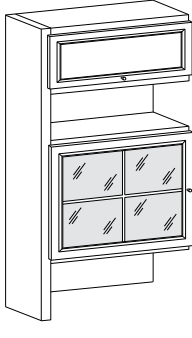
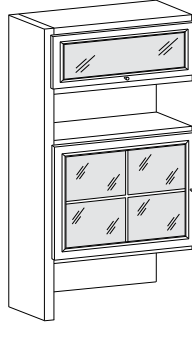
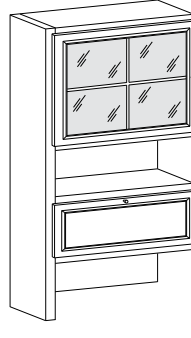
H. 2026
L. w. 921

<p>Modulo L. 921 Width W. 921</p> 	 <p>ZS.90501</p>	 <p>ZS.90502</p>	 <p>ZS.90503</p>	 <p>ZS.90504</p>	 <p>ZS.90505</p>
<p>Profondità Depth 377</p>	<p>660,00</p>	<p>799,00</p>	<p>1.029,00</p>	<p>1.072,00</p>	<p>1.302,00</p>
					
<p>ZS.90506</p>	<p>ZS.90507</p>	<p>ZS.90508</p>	<p>ZS.90509</p>	<p>ZS.90510</p>	<p>ZS.90511</p>
<p>1.345,00</p>	<p>1.259,00</p>	<p>1.024,00</p>	<p>1.249,00</p>	<p>1.228,00</p>	<p>1.288,00</p>
					
<p>ZS.90512</p>	<p>ZS.90513</p>	<p>ZS.90514</p>	<p>ZS.90515</p>	<p>ZS.90516</p>	<p>ZS.90517</p>
<p>1.271,00</p>	<p>1.331,00</p>	<p>1.223,00</p>	<p>1.283,00</p>	<p>1.254,00</p>	<p>1.297,00</p>

MADIA COMPLANARE

FLUSH-FITTING SIDEBOARDS

H. 824
P. D. **450**

- Disponibile con piedi "FUTON" di serie
- Available with "FUTON" feet as standard
- Attrezzatura interna: Divisione interna più due ripiani vetro
- Internal equipment: Internal partition plus two glass shelves

Codice
Code

Laccato, laccato consumato, Frassino tinto,
Frassino laccato opaco, Frassino decapè
lacquered, "Consumato" laquered, Stained ash-wood,
Ash-wood matt lacquered, Ash-wood "decapè"

CON 2 ANTE SCORREVOLI COMPLANARI L. 1746

FLUSH-FITTING SIDEBOARDS W. 1746

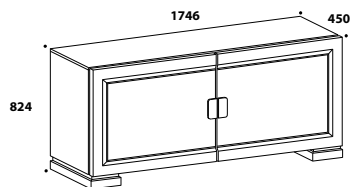

Z.595

1.720,00

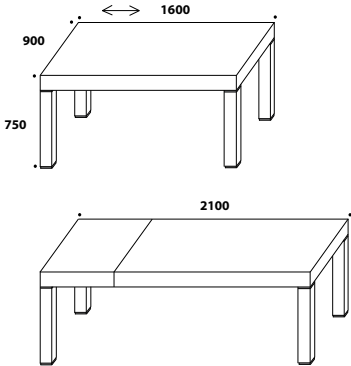
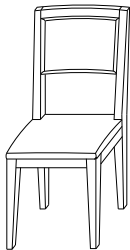

TAVOLI E SEDIE

TABLES AND CHAIRS

		Codice Code	Frassino tinto, Frassino laccato opaco, Frassino decapè Stained ash-wood, Ash-wood matt lacquered, Ash-wood "decapè"
<p>TAVOLO "PEGASO" L. 1600-2100 H. 750 "PEGASO" TABLE W. 1600-2100 H. 750</p> 		Z.863	1.399,00
<p>SEDIA "SIRIO" P. 450 H. 830 "SIRIO" CHAIR D. 450 H. 830</p> <ul style="list-style-type: none"> • Senza braccioli • Provided with levelling feet • Colore tessuto ecru • Ecru fabric  <p>Maggiorazione tessuto cliente: € 35,00 Surcharge for customer's fabric: € 35,00</p>		Z.936	200,00



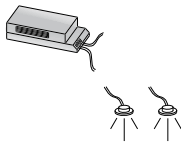
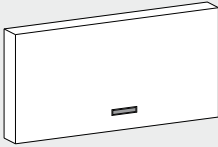
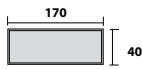
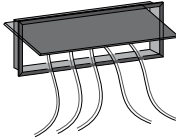
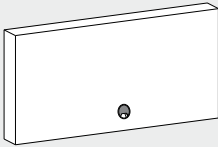

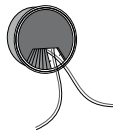
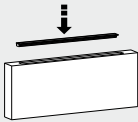
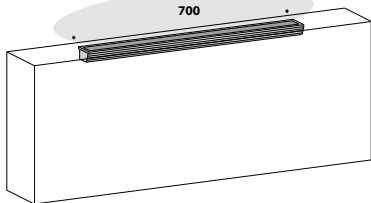
ACCESSORI

ACCESSORIES

		Codice Code	FINITURE FINISHINGS	
<p>COPPIA FARETTI A INCASSO PAIR OF BUILT IN SPOTLIGHTS WITH TRANSFORMER</p> <p>Elemento completo di trasformatore, cavo e interruttore Equipped with transformer, cable and switch</p> 		Y.624	Finitura nichelata Nickelated finishing	136,00
		Y.625	Finitura nera Black finishing	140,00
<p>PASSACAVI RETTANGOLARE RECTANGULAR CABLE HOLE</p> <p>Applicazioni: può essere previsto su top, su basi, ripiani e schiene attrezzate Applications: can be envisaged on tops, base modules, shelves and hanging panels</p>   		X.888	Alluminio Aluminium	35,00
<p>TAPPO PASSACAVI ROTONDO ROUND CABLE HOLE PLUG</p> <p>Applicazioni: può essere previsto su top, su basi, ripiani e schiene attrezzate Applications: can be envisaged on tops, base modules, shelves and hanging panels</p>   		X.889	Nero, Bianco, Alluminio Black, white, aluminium	35,00
<p>ASTA LUMINOSA L. 700 LIGHT RAIL W. 700</p> <p>Applicazioni: può essere inserita su schiene attrezzate spessore 80, o sp. 26 top o elementi montati Applications: can be fitted into hanging panels th. 80 or 26 tops or upright modules</p>  		Y.628	Alluminio Aluminium	185,00

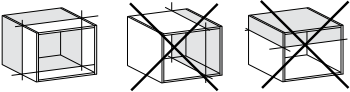
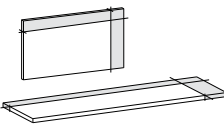
LAVORAZIONI SPECIALI E SU MISURA

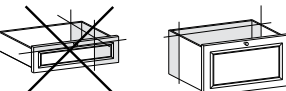
SPECIAL WORKING AND CUSTOM MADE

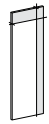
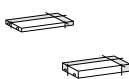
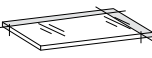
		PREZZO: PRICE:	
	Riduzione in profondità di scocche di elementi montati, NON è prevista la riduzione in lunghezza ed altezza in presenza di frontali Reduction in depth of structures of fitted modules, is not provided the reduction in length and height in the presence of frontal	100,00	
	Riduzione in lunghezza, profondità e altezza di top mensole o schiene attrezzate: Reduction in length, depth and height of tops, shelves or hanging panels:	36,00	
	NON è prevista la riduzione in larghezza e altezza di frontali legno Is not provided the reduction in height and length of wooden frontal	-	
	NON è prevista la riduzione in larghezza e altezza di frontali vetro Is not provided the reduction in height and length of glass frontal	-	
	Riduzione in profondità di cassetto o cestone, NON è prevista la riduzione in altezza e lunghezza di cassetto o cestone Reduction in depth of drawer or high drawer, is not provided the reduction in length and height	75,00	
	Riduzione in altezza e profondità spalla libreria: Reduction in height and depth of bookcase side:	36,00	
	Riduzione in altezza e lunghezza schiena libreria: Reduction in height and length of bookcase back panel:	36,00	
	Riduzione in lunghezza e profondità ripiano legno o fondo libreria: Riduzione in lunghezza e profondità ripiano legno o fondo libreria:	36,00	
	Riduzione in lunghezza e profondità ripiano vetro: Reduction in length and depth of glass shelf:	40,00	
	BIFACCIALE: Maggiorazione per ogni singolo elemento libreria FINISHED ON BACK SIDE: Surcharge for each individual bookcase module	30,00	
	PANNELLO DI FINITURA: A spessore 18 (dimensioni massime 2500 X 850) al mq FINISHING PANEL: 18 thick (max. dimensions 2500 X 850) per m2	Essenza / Laccato opaco Wood / Matt lacquered	80,00
		Laccato lucido Gloss lacquered	130,00
	LACCATURA A CAMPIONE: Da scala RAL o campione del cliente (costo fisso a forfait) LACQUERING AS PER SAMPLE: From RAL scale or customer's sample (fixed one-off cost)		100,00
	Lavorazioni su misura particolari non previste in questa pagina andranno concordate con l'ufficio vendite. Special custom-working not envisaged on this page shall be agreed upon with the sales dept.		

COMPOSIZIONI A CATALOGO

COMPOSITION AS PER CATALOGUE

COMPOSIZIONE COMPOSITION 104

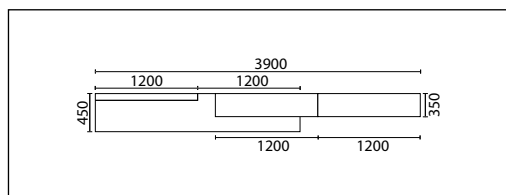

CARATTERISTICHE: **Basi, mensola e pensili frassino laccato bianco ottico, schiena porta tv e carabottino frassino laccato ecru**
FEATURES: Base modules, shelves and hanging modules "frassino laccato bianco ottico", adjustable element for television and "scarabeo" hanging module "frassino laccato ecru"

- ARTICOLI:** 2 **Z.207** Base 1 cassettoni L. 1200 H. 401 P. 450 Base module 1 high drawer W. 1200 H. 401 D. 450
 1 **Z.537** Top per base L. 2400 Sp. 26 P. 450 Top for base module L. 2400 D. 450 Th. 26
 1 **Z.833** Mensola speciale dx alto L. 2400 H. 427 P. 280 Right up special shelf L. 2400 H. 427 D. 280
 2 **Z.118** Pensile "Scarabeo" L. 1200 H. 300 P. 348 "Scarabeo" hanging module W.1200 H.300 D.348
 2 **Z.251** Pensile vasistas vetro L. 1200 H. 401 P. 350 Vasistas glass door hanging module W. 1200 H. 401 D. 350
 1 **Z.661** Schiena grossa c/cornice L. 1200 H. 802 Sp. 80 Thick back panek with frame W.1200 H.802 Th.80

DIMENSIONI: L. W. 3900
DIMENSIONS: H. H. 1850
 P. D. 450 - 350
Volume: Volume: 1,521

PREZZO: Come foto frassino
PRICE: As in photo ash-wood **3.690,00**

COMPOSIZIONE COMPOSITION 107

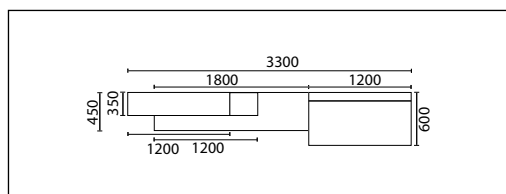

CARATTERISTICHE: **Basi, pensile e cornice frassino tinto cuba, pensile vetro e schiena porta tv frassino tinto ecru**
FEATURES: Base modules, hanging modules and frame "frassino tinto cuba", hanging glass module and adjustable element for television "frassino tinto ecru"

- ARTICOLI:** 1 **Z.295** Base bassa 2 cassetti L. 1800 H. 201 P. 450 Low base module 2 drawers W. 1800 H. 201 D. 450
 1 **Z.287** Base porta tv speciale L. 1200 H. 487 P. 600 Special tv holder base module W. 1200 H. 487 P. 600
 1 **Z.877** Porta tv orientabile c/cornice L. 1200 H. 917 P. 105 Adjustable TV holder with frame W.1200 H.917 D.105
 1 **Z.253** Pensile vasistas legno L. 1200 H. 401 P. 350 Vasistas wooden door hanging module W. 1200 H. 401 D. 350
 1 **Z.252** Pensile ribalta legno L. 1200 H. 401 P. 350 Hanging module with wooden flap W.1200 H. 401 D. 350
 1 **Z.250** Pensile ribalta vetro L. 1200 H. 401 P. 350 Glass flap door hanging module W. 1200 H. 401 D. 350
 1 **Z.515** Top per base L. 1800 Sp. 26 P. 450 Top for base module L. 1800 D. 450 Th. 26
 1 **Z.975** Zoccolo frontale Front plinth
 1 **Z.979** Zoccolo laterale sx base sporgente P. 451 Plinth left side D.451
 2 **Z.999** Piedino per zoccolo "Zenith" For "Zenith" plinth foot

DIMENSIONI: L. W. 3300
DIMENSIONS: H. H. 1750
 P. D. 600 - 450 - 350
Volume: Volume: 1,261

PREZZO: Come foto frassino
PRICE: As in photo ash-wood **3.671,00**

COMPOSIZIONE COMPOSITION 110

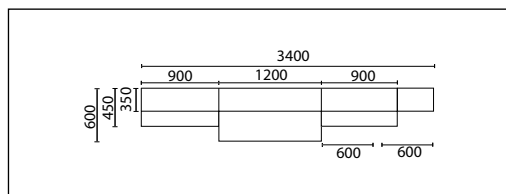

CARATTERISTICHE: **Tutto frassino laccato ecru decape bianco**
FEATURES: All laquered "frassino laccato ecru decape bianco"

- ARTICOLI:** 2 **Z.199** Base 1 cassettoni L. 900 H. 401 P. 450 Base module 1 high drawer W. 900 H. 401 D. 450
 1 **Z.287** Base porta tv speciale L. 1200 H. 487 P. 600 Special tv holder base module W. 1200 H. 487 P. 600
 1 **Z.717** Mensola legno L. 901 Sp. 51 P. 280 Wooden shelf W. 901 D. 280 Th. 51
 2 **Z.024** Pensile 1 anta legno L. 600 H. 601 P. 350 Hanging module 1 wooden door W. 600 H. 601 D. 350
 2 **Z.248** Pensile vasistas legno L. 900 H. 401 P. 350 Vasistas wooden door hanging module W. 900 H. 401 D. 350
 1 **Z.253** Pensile vasistas legno L. 1200 H. 401 P. 350 Vasistas wooden door hanging module W. 1200 H. 401 D. 350
 2 **Z.512** Top per base L. 900 Sp. 26 P. 450 Top for base module L. 900 D. 450 Th. 26
 2 **Z.714** Supporti a scomparsa reg. per mensole Adj. Concealed supports for shelves
 2 **Z.975** Zoccolo frontale Front plinth
 1 **Z.978** Zoccolo laterale dx base sporgente P. 451 Plinth right side D.451
 1 **Z.979** Zoccolo laterale sx base sporgente P. 451 Plinth left side D.451
 2 **Z.999** Piedino per zoccolo "Zenith" For "Zenith" plinth foot

DIMENSIONI: L. W. 3400
DIMENSIONS: H. H. 1830
 P. D. 600 - 450 - 350
Volume: Volume: 1,566

PREZZO: Come foto frassino decape bianco
PRICE: As in photo ash-wood "decape bianco" **4.191,00**

COMPOSIZIONI A CATALOGO

COMPOSITION AS PER CATALOGUE

COMPOSIZIONE COMPOSITION 112

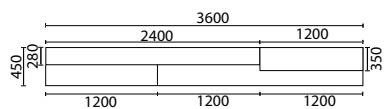

CARATTERISTICHE:

FEATURES:

Basi frassino tinto camoscio, pensile, mensole e schiena frassino tinto ecru

Base modules "frassino tinto camoscio", hanging module and back panel "frassino tinto ecru"

- ARTICOLI:** 1 **Z.240** Base 4 ante legno L. 1200 H. 1203 P. 450
ARTICLES: 2 **Z.207** Base 1 cassettone L. 1200 H. 401 P. 450
 1 **Z.537** Top per base L. 2400 Sp. 26 P. 450
 1 **Z.534** Top per base L. 1200 Sp. 26 P. 450
 1 **Z.227** Pensile 2 ante vetro L. 1200 H. 601 P. 350
 1 **Z.728** Mensola legno L. 2401 Sp. 51 P. 280
 3 **Z.720** Mensola legno L. 1200 Sp. 51 P. 280
 10 **Y.714** Supporti a scomparsa reg. per mensole
 1 **Z.666** Schiena attrezzata L. 2400 H. 274 Sp. 26
 3 **Z.846** Zoccolo L. 1200 H. 35 P. 425
 1 **Z.667** Schiena attrezzata L. 1200 H. 776 Sp. 26

- Base module 4 wooden doors W. 1200 H. 1203 D. 450
 Base module 1 high drawer W. 1200 H. 401 D. 450
 Top for base module L. 2400 D. 450 Th. 26
 Top for base module L. 1200 D. 450 Th. 26
 Hanging module 2 cristal doors W. 1200 H. 601 D. 350
 Wooden shelf W. 2401 D. 280 Th. 51
 Wooden shelf W. 1200 D. 280 Th. 51
 Adj. Concealed supports for shelves
 Hanging panel W. 2400 H. 274 Th. 26
 Plinth W.1200 H.35 D.425
 Hanging panel W. 1200 H. 776 Th. 26

DIMENSIONI:

DIMENSIONS:

L. W. 3600
 H. H. 1800
 P. D. 450 - 350
 Volume: Volume: 1,861

PREZZO:

PRICE:

Come foto frassino
 As in photo ash-wood

3.769,00

COMPOSIZIONE COMPOSITION 114

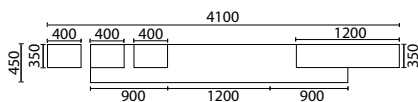

CARATTERISTICHE:

FEATURES:

Basi, pensili laccato bianco opaco lucido (listino Horizon), pensile frassino tinto miele

Base modules and hanging modules gloss laquered "bianco opaco" (price list Horizon), hanging module "frassino tinto miele"

- ARTICOLI:** 2 **X.199** Base 1 cassettone L. 900 H. 401 P. 450
ARTICLES: 1 **X.207** Base 1 cassettone L. 1200 H. 401 P. 450
 1 **X.541** Top per base L. 3002 P. 450 Sp. 12
 3 **X.812** Confezione 4 piedi rotondi bassi H. 18
 3 **X.048** Pensile 1 anta legno H. 1203 L. 400 P. 350
 1 **Z.23001** Pensile 4 ante vetro c/inglesina L. 1200 H. 1203 P. 350

- Base module 1 high drawer W. 900 H. 401 D. 450
 Base module 1 high drawer W. 1200 H. 401 D. 450
 Top for base module L. 3002 D. 450 Th. 12
 Pack of 4 low round feet H. 18
 Hanging module 1 wooden door W. 1203 H. 400 D. 350
 Hanging module 4 cristal doors with grating W. 1200 H.1203 D. 350

DIMENSIONI:

DIMENSIONS:

L. W. 4100
 H. H. 2000
 P. D. 450 - 350
 Volume: Volume: 1,702

PREZZO:

PRICE:

Come foto laccato lucido e frassino
 As in photo gloss lacquered and ash-wood

4.495,00

COMPOSIZIONE COMPOSITION 105

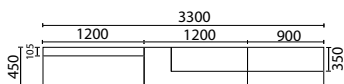

CARATTERISTICHE:

FEATURES:

Tutto frassino blu provenza decape bianco

All "frassino blu provenza decape bianco"

- ARTICOLI:** 2 **Z.207** Base 1 cassettone L. 1200 H. 401 P. 450
ARTICLES: 1 **Z.199** Base 1 cassettone L. 900 H. 401 P. 450
 1 **Z.537** Top per base L. 2400 Sp. 26 P. 450
 1 **Z.512** Top per base L. 900 Sp. 26 P. 450
 1 **Z.877** Porta tv orientabile c/cornice L. 1200 H. 917 P. 105
 2 **Z.066** Pensile 1 anta vetro L. 900 H. 802 P. 350
 1 **Z.975** Zoccolo frontale
 1 **Z.978** Zoccolo laterale dx base sporgente P. 451
 1 **Z.979** Zoccolo laterale sx base sporgente P. 451
 3 **Z.999** Piedino per zoccolo "Zenith"

- Base module 1 high drawer W. 1200 H. 401 D. 450
 Base module 1 high drawer W. 900 H. 401 D. 450
 Top for base module L. 2400 D. 450 Th. 26
 Top for base module L. 900 D. 450 Th. 26
 Adjustable TV holder with frame W.1200 H.917 D.105
 Hanging module 1 cristal door W. 900 H. 802 D. 350
 Front plinth
 Plinth right side D.451
 Plinth left side D.451
 For "Zenith" plinth foot

DIMENSIONI:

DIMENSIONS:

L. W. 3300
 H. H. 1630
 P. D. 450 - 350
 Volume: Volume: 1,306

PREZZO:

PRICE:

Come foto frassino decape bianco
 As in photo ash-wood "decape bianco"

3.449,00

COMPOSIZIONI A CATALOGO

COMPOSITION AS PER CATALOGUE

COMPOSIZIONE COMPOSITION 111

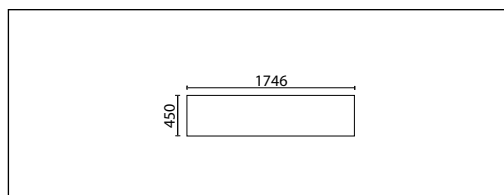

CARATTERISTICHE: Tutto frassino tinto miele
FEATURES: All "frassino tinto miele"

ARTICOLI: 1 **Z.595** Madia 2 ante complanari L. 1746 H. 824 P. 450
ARTICLES: Flush-fitting sideboards W. 1746 H. 824 D. 450

DIMENSIONI: L. W. 1746
DIMENSIONS: H. H. 824
 P. D. 450
Volume: Volume: 0,683

PREZZO: Come foto frassino
PRICE: As in photo ash-wood **1.720,00**

COMPOSIZIONE COMPOSITION 101

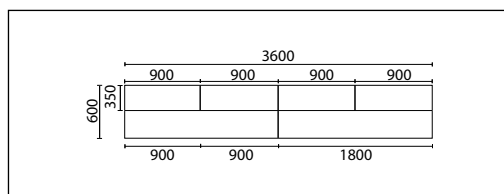

CARATTERISTICHE: Tutto laccato bianco ottico consumato opaco
FEATURES: All laquered "bianco ottico consumato opaco"

ARTICOLI: 2 **Z.199-60** Base 1 cassettoni L. 900 H. 401 P. 600
ARTICLES: Base module 1 high drawer W. 900 H. 401 D. 600
 1 **Z.295-60** Base 2 cassetti L. 1800 H. 201 P. 600
 Base module 2 drawers W. 1800 H. 201 D. 600
 2 **Z.505** Top per base L. 1801 P. 603 Sp. 26
 Top for base module L. 1801 D. 603 Th. 26
 2 **Z.024** Pensile 1 anta legno L. 600 H. 601 P. 350
 Hanging module 1 wooden door W. 600 H. 601 D. 350
 2 **Z.246** Pensile vasistas vetro L. 900 H. 401 P. 350
 Vasistas glass door hanging module W. 900 H. 401 D. 350
 1 **Z.119** Pensile "Scarabeo" L. 1800 H. 300 P. 348
 "Scarabeo" hanging module W.1800 H.300 D.348
 1 **Z.975** Zoccolo frontale
 Front plinth
 1 **Z.976** Zoccolo laterale dx base sporgente P. 601
 Plinth right side D.601
 1 **Z.977** Zoccolo laterale sx base sporgente P. 601
 Plinth left side D.601
 4 **Z.999** Piedino per zoccolo "Zenith"
 For "Zenith" plinth foot

DIMENSIONI: L. W. 3600
DIMENSIONS: H. H. 2000
 P. D. 600 - 350
Volume: Volume: 1,565

PREZZO: Come foto laccato bianco consumato opaco
PRICE: As in photo matt laquered "bianco consumato" **4.240,00**

COMPOSIZIONE COMPOSITION 113

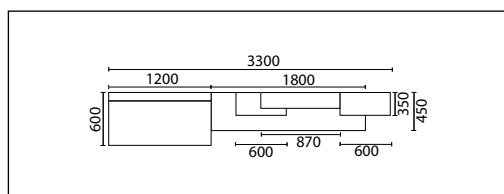

CARATTERISTICHE: Basi, porta tv frassino tinto cuba, libreria pensile (listino Horizon) frassino tinto cuba, pensili frassino laccato corda
FEATURES: Base modules, adjustable element for television "frassino tinto cuba", hanging bookcase (price list Horizon) "frassino tinto cuba", hanging modules "frassino laccato corda"

ARTICOLI: 1 **Z.295** Base bassa 2 cassetti L. 1800 H. 201 P. 450
ARTICLES: Low base module 2 drawers W. 1800 H. 201 D. 450
 1 **Z.287** Base porta tv speciale L. 1200 H. 487 P. 600
 Special tv holder base module W. 1200 H. 487 P. 600
 1 **Z.876** Porta tv orientabile c/cornice L. 1200 H. 802 P. 105
 Adjustable TV holder with frame W.1200 H.802 D.105
 1 **Z.515** Top per base L. 1800 Sp. 26 P. 450
 Top for base module L. 1800 D. 450 Th. 26
 1 **Z.975** Zoccolo frontale
 Front plinth
 1 **Z.979** Zoccolo laterale sx base sporgente P. 451
 Plinth left side D.451
 3 **Z.003** Pensile 1 anta vetro L. 600 H. 401 P. 350
 Hanging module 1 cristal door W. 600 H. 401 D. 350
 2 **X.4522** Ripiano libreria L. 870 P. 277 Sp. 30
 Shelf W. 870 D. 277 Th. 30
 2 **X.4552** Ripiano libreria L. 300 P. 277 Sp. 30
 Shelf W. 300 D. 277 Th. 30
 1 **X.4512** Ripiano libreria L. 570 P. 277 Sp. 30
 Shelf W. 570 D. 277 Th. 30
 2 **X.5812** Spalla appesa libreria H. 331 P. 277 Sp. 30
 Hanging side H. 331 D. 277 Th. 30
 2 **X.5852** Spalla appesa libreria H. 631 P. 277 Sp. 30
 Hanging side H. 631 D. 277 Th. 30
 2 **Y.711** Supporti a scomparsa per mensole
 Concealed supports for shelves
 2 **Z.999** Piedino per zoccolo "Zenith"
 For "Zenith" plinth foot

DIMENSIONI: L. W. 3300
DIMENSIONS: H. H. 1530
 P. D. 600 - 450 - 350
Volume: Volume: 1,034

PREZZO: Come foto frassino
PRICE: As in photo ash-wood **3.935,00**

COMPOSIZIONI A CATALOGO

COMPOSITION AS PER CATALOGUE

COMPOSIZIONE COMPOSITION 102

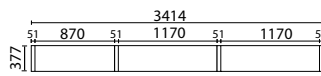

CARATTERISTICHE:

FEATURES:

Struttura libreria, ante frassino laccato ecru, schiena libreria laccato lilla opaco

Bookcase structure, frontals "frassino laccato ecru", back panels laquered "lilla opaco"

ARTICOLI:

ARTICLES:

4	Z.418G	Spalla a terra H. 1682 P. 377 Sp. 51	Side to floor H. 1682 D. 377 Th. 51
2	Z.435	Spalla supporto H. 428 P. 377 Sp. 30	Supporting side H. 428 D. 377 Th. 30
4	Z.447	Fondo L. 570 Sp. 57 P. 376	Bottom W. 570 D. 376 Th. 57
1	Z.448	Fondo L. 870 Sp. 57 P. 376	Bottom W. 870 D. 376 Th. 57
1	Z.452G	Ripiano L. 870 Sp. 51 P. 377	Shelf W. 870 D. 377 Th. 51
3	Z.452GR	Ripiano ridotto L. 870 P. 362 Sp. 51	Reduced shelf W. 870 D. 362 Th. 51
6	Z.453G	Ripiano L. 1170 Sp. 51 P. 377	Shelf W. 1170 D. 377 Th. 51
1	Z.453GR	Ripiano ridotto L. 1170 P. 362 Sp. 51	Reduced shelf W. 1170 D. 362 Th. 51
2	Z.396	Anta vasistas vetro L. 1197 H. 398 Sp. 23	Glass Vasistas door W. 1197 H. 398 Th. 23
1	Z.404	Anta vasistas vetro L. 897 H. 398 Sp. 23	Glass Vasistas door W. 897 H. 398 Th. 23
1	Z.395	Anta ribalta vetro L. 1197 H. 398 Sp. 23	Glass flap door W. 1197 H. 398 Th. 23
1	Z.329	1 cassettoni libreria L. 900 H. 401 P. 377	1 high drawer for width W. 900 H. 401 D. 377
2	Z.399	1 cassettoni libreria L. 1200 H. 401 P. 377	1 high drawer for width W. 1200 H. 401 D. 377
2	Z.372	Schiena libreria H. 371 L. 1170 Sp. 12	Back panel H. 371 L. 1170 Th. 12
2	Z.373	Schiena libreria H. 772 L. 1170 Sp. 12	Back panel H. 772 L. 1170 Th. 12
4	Z.358	Schiena libreria H. 371 L. 570 Sp. 12	Back panel H. 371 L. 570 Th. 12
1	Z.368	Schiena libreria H. 1574 L. 870 Sp. 12	Back panel H. 1574 L. 870 Th. 12

DIMENSIONI:

DIMENSIONS:

L. W. 3414
H. H. 1682
P. D. 377
Volume: Volume: 1,529

PREZZO:

PRICE:

Come foto frassino e laccato opaco
As in photo ash-wood and matt laquered

4.799,00

COMPOSIZIONE COMPOSITION 109

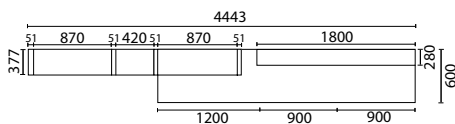

CARATTERISTICHE:

FEATURES:

Struttura libreria, ante libreria bianco ottico consumato, schiene libreria, basi, mensola speciale frassino tinto grigio

Bookcase structure, frontals "bianco ottico consumato", back panels, base modules, special shelves "frassino tinto grigio"

ARTICOLI:

ARTICLES:

3	Z.418G	Spalla a terra H. 1682 P. 377 Sp. 51	Side to floor H. 1682 D. 377 Th. 51
1	Z.424G	Spalla sopralzo H. 1224 P. 377 Sp. 51	Side to floor H. 1224 D. 377 Th. 51
1	Z.446	Fondo L. 420 Sp. 57 P. 376	Bottom W. 420 D. 376 Th. 57
1	Z.448	Fondo L. 870 Sp. 57 P. 376	Bottom W. 870 D. 376 Th. 57
2	Z.452G	Ripiano L. 870 Sp. 51 P. 377	Shelf W. 870 D. 377 Th. 51
2	Z.452GR	Ripiano ridotto L. 870 P. 362 Sp. 51	Reduced shelf W. 870 D. 362 Th. 51
1	Z.450G	Ripiano strutturale L. 420 P. 377 Sp. 51	Structural shelf W. 420 D. 377 Th. 51
4	Z.450GR	Ripiano ridotto L. 450 P. 362 Sp. 51	Reduced shelf W. 450 D. 362 Th. 51
1	Z.354	Schiena libreria H. 1574 L. 420 Sp. 12	Back panel H. 1574 L. 420 Th. 12
1	Z.368	Schiena libreria H. 1574 L. 870 Sp. 12	Back panel H. 1574 L. 870 Th. 12
1	Z.367	Schiena libreria H. 1173 L. 870 Sp. 12	Back panel H. 1173 L. 870 Th. 12
3	Z.762	Ripiani cristallo L. 868 P. 340 Sp. 8	Glass shelves W. 868 D. 340 Th. 8
3	Z.326	Anta vetro (per modulo L. 900)	Glass door (for width W. 900)
2	Z.199-60	Base 1 cassettoni L. 900 H. 401 P. 600	Base module 1 high drawer W. 900 H. 401 D. 600
1	Z.207-60	Base 1 cassettoni L. 1200 H. 401 P. 600	Base module 1 high drawer W. 1200 H. 401 D. 600
1	Z.530	Top per basi L. 3002 P. 603 Sp. 26	Top for base module L. 3002 D. 603 Th. 26
1	Z.838	Mensola speciale dx alto L. 1801 H. 426 P. 280	Right up special shelf W. 1801 H. 426 D. 280
1	Z.846	Zoccolo L. 1200 H. 35 P. 425	Plinth W.1200 H.35 D.425
2	Z.849	Zoccolo L. 900 H. 35 P. 425	Plinth W.900 H.35 D.425
3	Z.999	Piedino per zoccolo "Zenith"	For "Zenith" plinth foot

DIMENSIONI:

DIMENSIONS:

L. W. 4443 P. D. 600 - 377
H. H. 1682 Volume: Volume: 1,79

PREZZO:

PRICE:

Come foto laccato opaco consumato e frassino
As in photo matt laquered "consumato" and ash-wood

4.792,00

COMPOSIZIONE COMPOSITION 115

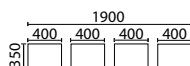

CARATTERISTICHE:

FEATURES:

Pensili frassino laccato bianco ottico, pensili laccato bianco ottico lucido (listino Horizon)

Hanging modules "frassino laccato bianco ottico", hanging modules glass laquered "bianco ottico" (price list Horizon)

ARTICOLI:

ARTICLES:

2	Z.048	Pensile 1 anta legno H. 1203 L. 400 P. 350	Hanging module 1 wooden door W. 1203 H. 400 D. 350
2	X.048	Pensile 1 anta legno H. 1203 L. 400 P. 350	Hanging module 1 wooden door W. 1203 H. 400 D. 350

DIMENSIONI:

DIMENSIONS:

L. W. 1900
H. H. 1700
P. D. 350
Volume: Volume: 0,716

PREZZO:

PRICE:

Come foto frassino e laccato lucido
As in photo ash-wood and glass laquered

1.802,00

Frassino e laccato opaco
Ash-wood and matt laquered

1.380,00

CONDIZIONI GENERALI DI VENDITA

GENERAL CONDITIONS OF SALE

Ogni articolo presente in questo listino può essere variato o eliminato anche senza preavviso alla clientela. I prezzi al pubblico sono espressi in euro e si intendono I.V.A. esclusa, posa in opera e qualsiasi altra prestazione escluse.

ORDINI E PREZZI

Tutti gli ordini o commissioni si intendono perfezionati con la nostra conferma scritta o verbale che comporta l'accettazione di tutte le nostre condizioni generali di vendita.

Le forniture verranno effettuate ai prezzi che risultano dalle conferme d'ordine o, in mancanza di queste ultime ai prezzi di listino in vigore all'atto della consegna.

TERMINI DI CONSEGNA

Le consegne verranno effettuate compatibilmente con le possibilità di approvvigionamento e trasporto. I termini di consegna indicati nella conferma hanno unicamente valore indicativo.

Non si accettano responsabilità né penalità su eventuali ritardi di consegna.

SOSTITUZIONI

Non si accettano resi se non espressamente autorizzati dall'Azienda.

I resi che vengono accettati si intendono con l'addebito di eventuali parti deprezzate o rovinate.

RECLAMI

I reclami, di qualunque genere essi siano, devono essere effettuati in forma scritta entro otto giorni dal ricevimento della merce.

Eventuali danni riscontrati alla merce e causati dal trasporto dovranno essere notificati al ricevimento della stessa.

PAGAMENTI

L'acquirente è tenuto al pagamento nei termini indicati dalla fattura senza praticare alcun arrotondamento. Il cliente non può differire o sospendere i pagamenti oltre le scadenze pattuite. Il mancato o ritardato pagamento anche di una sola rata comporterà la decadenza del beneficio di tutti i termini pattuiti, rendendo immediatamente esigibile l'intero credito, e lo costituirà in mora. Gli effetti sono da noi accettati salvo buon fine e non costituiscono novazione di credito.

TRASPORTO

Porto franco per consegne di importo superiore a Euro 1.250,00 (prezzo di listino), diversamente addebito in fattura di euro 150,00 per consegne aventi cubatura inferiore a 1,5 mc.

INADEMPIENZE

La mancata osservanza da parte del Cliente delle presenti condizioni generali di vendita e in quanto convenuto negli ordini o nelle commissioni, comporterà fra l'altro la sospensione delle forniture. Il ritardo di pagamento autorizza MOBILGAM s.p.a. a chiedere il pagamento totale con l'addebito di interessi di mora.

PUBBLICITÀ

Per pubblicizzare con foto o altri mezzi la merce fornita è necessaria la preventiva autorizzazione scritta della ditta fornitrice.

FORO COMPETENTE

Tutto ciò che non è regolato dalle presenti condizioni di vendita è disciplinato dalla legge italiana. Ogni controversia tra le parti in relazione alle vendite sarà di competenza del foro di Treviso - Pordenone, ferma la facoltà per la ditta MOBILGAM s.p.a. di adire, a sua discrezione, il foro del luogo ove il Cliente ha sede.

I PREZZI SONO ESPRESSI IN EURO

The seller reserves the right to make any alterations to its production at any time, without giving prior notice.

Prices are quoted in Euro, VAT exempted, installation and any other service excluded.

ORDER AND PRICES

All orders, commission and agreements are considered as being finalized upon receipt of our written or verbal confirmation. The finalization of an agreement implies full acceptance of all general condition of sale.

Goods are supplied at the price list in force when the agreement was finalized.

TERMS OF DELIVERY

Deliveries shall be effected according the availability of goods or transport. Delivery dates are to be considered as indicative only. We shall not be held responsible for claims of any nature concerning damages due to delays, discontinuity or the total or partial suspension of deliveries.

RETURNED GOODS

Returns which aren't authorized by company are not accepted. Accepted returns are meant with the debit of any depreciations or damages.

COMPLAINTS

All complaints have to be done in written form, within 8 days since the good's arrive. Possible damages on goods caused by transport have to be notified on receipt of the goods.

PAYMENT

The buyer shall perform the payment within the terms indicated in the invoice without rounding off. For no reason whatsoever and under no right may the Client defer or suspend payments beyond the terms agreed, non-payment or the delayed payment of even a single installment shall result in the entire outstanding amount becoming immediately due and representing arrears.

SHIPMENT

Free of charge for supplies superior of Euro 1.250,00 (price list), otherwise Euro 150,00 will be debited for supplies with cubage inferior of 1,5 mc.

BREACH OF CONTRACT

The Client's non-observance of the present general conditions of sale and of the covenants indicated in orders, commissions or agreements, shall result, apart from any other action, in the supply being suspended. The delay in payment will authorize MOBILGAM s.p.a. to claim the total payment plus fault interests.

ADVERTISING

To advertise the furnished goods with photos or other means it is necessary the preventive written authorizations by the supplier company.

PLACE OF JURISDICTION

All the things not governed by the present general contractual conditions are governed by the Italian law.

Any disputes shall be submitted to the Treviso - Pordenone Law Court notwithstanding the faculty for MOBILGAM s.p.a. only to resort to any other court of lawing compliance with procedural law.

PRICES ARE CHARGED IN EURO